

# PMF3800SN

## N-channel TrenchMOS standard level FET

Rev. 03 — 11 November 2009

Product data sheet

## 1. Product profile

### 1.1 General description

Standard level N-channel enhancement mode Field-Effect Transistor (FET) in a plastic package using TrenchMOS technology. This product is designed and qualified for use in computing, communications, consumer and industrial applications only.

### 1.2 Features and benefits

- Electrostatically robust due to integrated protection diodes
- Saves PCB space due to small footprint
- Suitable for high frequency applications due to fast switching characteristics
- Suitable for logic level gate drive sources

### 1.3 Applications

- High-speed line drivers
- Relay drivers

### 1.4 Quick reference data

Table 1. Quick reference

| Symbol                         | Parameter                        | Conditions   | Min | Typ  | Max  | Unit     |
|--------------------------------|----------------------------------|--|-----|------|------|----------|
| $V_{DS}$                       | drain-source voltage             | $T_j \geq 25\text{ °C}; T_j \leq 150\text{ °C}$  | -   | -    | 60   | V        |
| $I_D$                          | drain current                    | $T_{sp} = 25\text{ °C}; V_{GS} = 10\text{ V};$ see <a href="#">Figure 1</a> and <a href="#">3</a>                          | -   | -    | 260  | mA       |
| $P_{tot}$                      | total power dissipation          | $T_{sp} = 25\text{ °C};$ see <a href="#">Figure 2</a>  | -   | -    | 0.56 | W        |
| <b>Dynamic characteristics</b> |                                  |  |     |      |      |          |
| $Q_{GD}$                       | gate-drain charge                | $V_{GS} = 10\text{ V}; I_D = 0.5\text{ A};$  | -   | 0.07 | -    | nC       |
| $Q_{G(tot)}$                   | total gate charge                | $V_{DS} = 48\text{ V}; T_j = 25\text{ °C};$ see <a href="#">Figure 11</a>  | -   | 0.85 | -    | nC       |
| <b>Static characteristics</b>  |                                  |  |     |      |      |          |
| $R_{DS(on)}$                   | drain-source on-state resistance | $V_{GS} = 4.5\text{ V}; I_D = 200\text{ mA};$<br>$T_j = 25\text{ °C};$ see <a href="#">Figure 9</a> and <a href="#">10</a> | -   | 3.8  | 5.3  | $\Omega$ |
|                                |                                  | $V_{GS} = 10\text{ V}; I_D = 500\text{ mA};$<br>$T_j = 25\text{ °C};$ see <a href="#">Figure 9</a> and <a href="#">10</a>  | -   | 2.8  | 4.5  | $\Omega$ |

## 2. Pinning information

Table 2. Pinning information

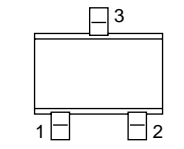
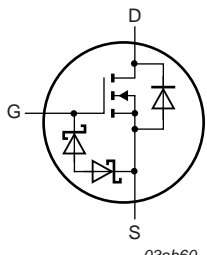
| Pin | Symbol | Description | Simplified outline   | Graphic symbol  |
|-----|--------|-------------|--|---|
| 1   | G      | gate        |  <p>SOT323 (SC-70)</p> |  <p>03ab60</p> |
| 2   | S      | source      |  |   |
| 3   | D      | drain       |  |   |

## 3. Ordering information

Table 3. Ordering information

| Type number | Package |  | Version |
|-------------|---------|--|---------|
|             | Name    | Description                              |         |
| PMF3800SN   | SC-70   | plastic surface-mounted package; 3 leads | SOT323  |

## 4. Marking

Table 4. Marking codes

| Type number | Marking code <sup>[1]</sup> |
|-------------|-----------------------------|
| PMF3800SN   | FK*                         |

- [1] \* = -: made in Hong Kong  
 \* = p: made in Hong Kong  
 \* = t: made in Malaysia  
 \* = W: made in China

## 5. Limiting values

Table 5. Limiting values

In accordance with the Absolute Maximum Rating System (IEC 60134).

| Symbol    | Parameter               | Conditions  | Min | Max  | Unit |
|-----------|-------------------------|---|-----|------|------|
| $V_{DS}$  | drain-source voltage    | $T_j \geq 25\text{ °C}; T_j \leq 150\text{ °C}$   | -   | 60   | V    |
| $V_{DGR}$ | drain-gate voltage      | $T_j \geq 25\text{ °C}; T_j \leq 150\text{ °C}; R_{GS} = 20\text{ k}\Omega$                       | -   | 60   | V    |
| $V_{GS}$  | gate-source voltage     |   | -15 | 15   | V    |
| $I_D$     | drain current           | $T_{sp} = 100\text{ °C}; V_{GS} = 10\text{ V};$ see <a href="#">Figure 1</a>                      | -   | 165  | mA   |
|           |                         | $T_{sp} = 25\text{ °C}; V_{GS} = 10\text{ V};$ see <a href="#">Figure 1</a> and <a href="#">3</a> | -   | 260  | mA   |
| $I_{DM}$  | peak drain current      | $T_{sp} = 25\text{ °C}; t_p \leq 10\text{ }\mu\text{s};$ pulsed; see <a href="#">Figure 3</a>     | -   | 560  | mA   |
| $P_{tot}$ | total power dissipation | $T_{sp} = 25\text{ °C};$ see <a href="#">Figure 2</a>   | -   | 0.56 | W    |
| $T_{stg}$ | storage temperature     |   | -55 | 150  | °C   |
| $T_j$     | junction temperature    |   | -55 | 150  | °C   |

**Table 5. Limiting values ...continued**

In accordance with the Absolute Maximum Rating System (IEC 60134).

| Symbol                                 | Parameter                       | Conditions  | Min | Max | Unit |
|--|---------------------------------|---|-----|-----|------|
| <b>Source-drain diode</b>              |                                 |   |     |     |      |
| $I_S$                                  | source current                  | $T_{sp} = 25\text{ }^\circ\text{C}$   | -   | 280 | mA   |
| $I_{SM}$                               | peak source current             | $T_{sp} = 25\text{ }^\circ\text{C}$ ; $t_p \leq 10\text{ }\mu\text{s}$ ; pulsed | -   | 560 | mA   |
| <b>Electrostatic discharge voltage</b> |                                 |   |     |     |      |
| $V_{ESD}$                              | electrostatic discharge voltage | HBM; C = 100 pF; R = 1.5 k $\Omega$   | -   | 1   | kV   |

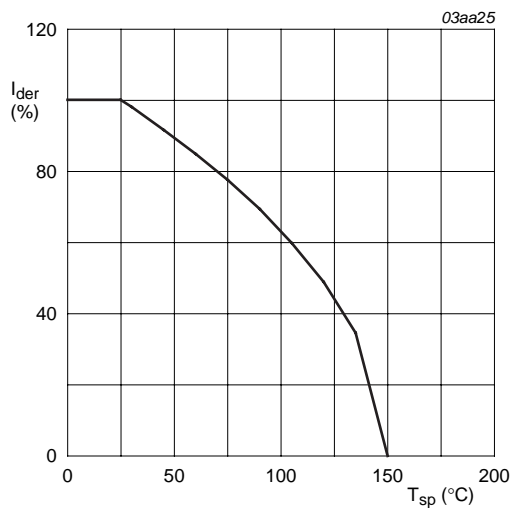

$$I_{der} = \frac{I_D}{I_{D(25^\circ\text{C})}} \times 100\%$$

**Fig 1. Normalized continuous drain current as a function of solder point temperature**

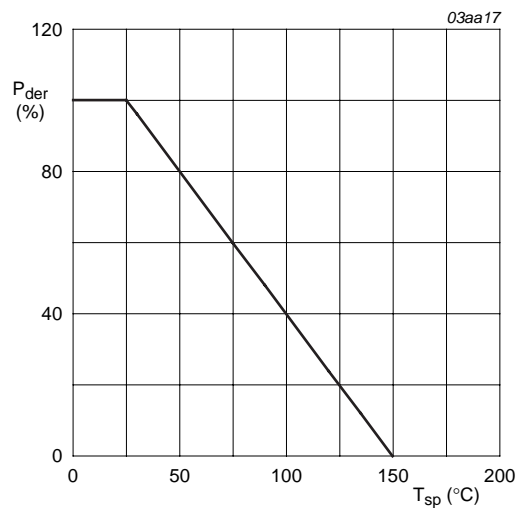

$$P_{der} = \frac{P_{tot}}{P_{tot(25^\circ\text{C})}} \times 100\%$$

**Fig 2. Normalized total power dissipation as a function of solder point temperature**

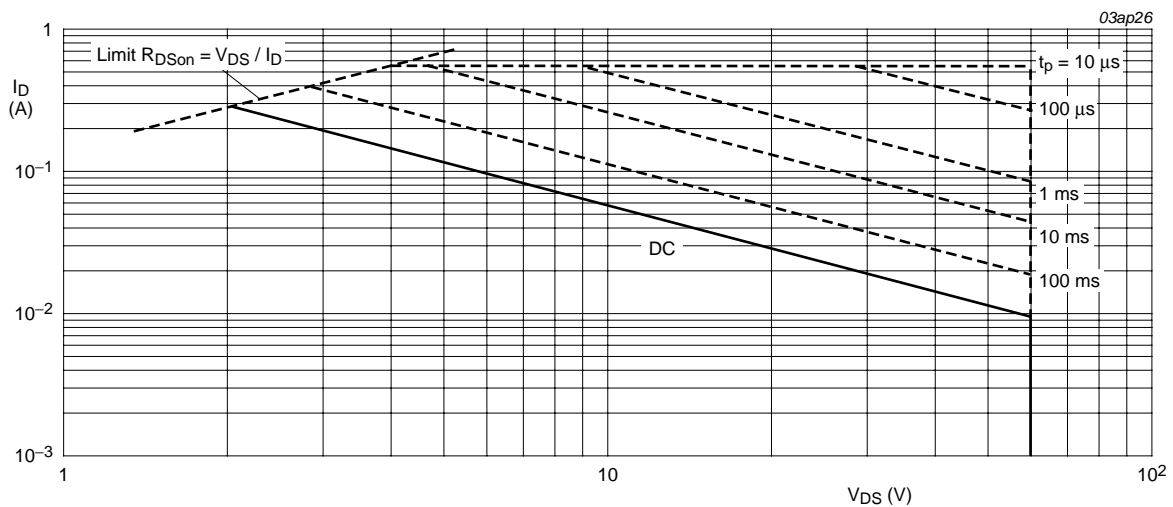

$T_{sp} = 25\text{ }^\circ\text{C}$ ;  $I_{DM}$  is single pulse

**Fig 3. Safe operating area; continuous and peak drain currents as a function of drain-source voltage**

## 6. Thermal characteristics

**Table 6. Thermal characteristics**

| Symbol         | Parameter  | Conditions                   | Min | Typ | Max | Unit |
|----------------|--|------------------------------|-----|-----|-----|------|
| $R_{th(j-sp)}$ | thermal resistance from junction to solder point | see <a href="#">Figure 4</a> | -   | -   | 220 | K/W  |

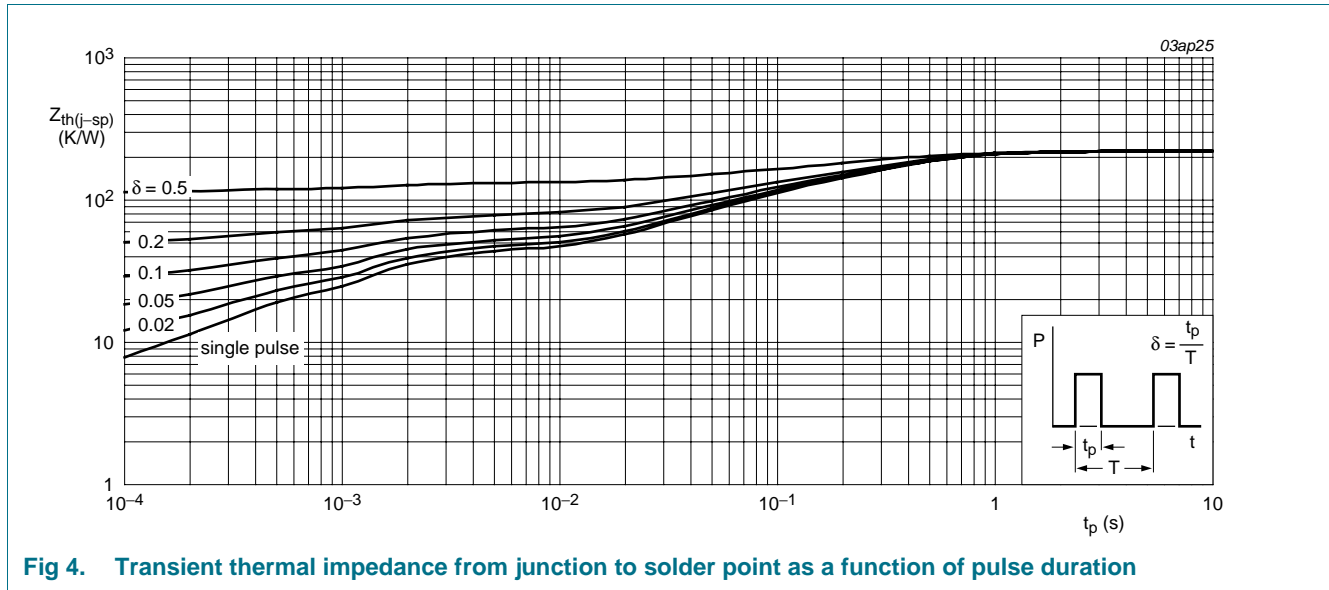
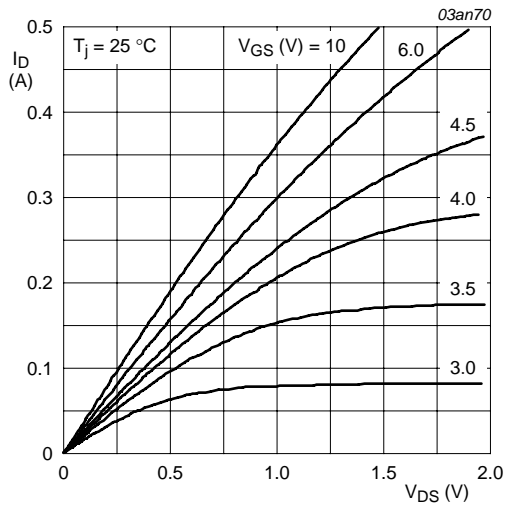

**Fig 4. Transient thermal impedance from junction to solder point as a function of pulse duration**

## 7. Characteristics

**Table 7. Characteristics**

| Symbol                         | Parameter                        | Conditions   | Min | Typ  | Max | Unit          |
|--------------------------------|----------------------------------|--|-----|------|-----|---------------|
| <b>Static characteristics</b>  |                                  |  |     |      |     |               |
| $V_{(BR)DSS}$                  | drain-source breakdown voltage   | $I_D = 10 \mu\text{A}; V_{GS} = 0 \text{ V}; T_j = -55 \text{ }^\circ\text{C}$   | 55  | -    | -   | V             |
|                                |                                  | $I_D = 10 \mu\text{A}; V_{GS} = 0 \text{ V}; T_j = 25 \text{ }^\circ\text{C}$  | 60  | -    | -   | V             |
| $V_{GS(th)}$                   | gate-source threshold voltage    | $I_D = 1 \text{ mA}; V_{DS} = V_{GS}; T_j = 150 \text{ }^\circ\text{C}$ ; see <a href="#">Figure 7</a> and <a href="#">8</a>   | 0.6 | -    | -   | V             |
|                                |                                  | $I_D = 1 \text{ mA}; V_{DS} = V_{GS}; T_j = -55 \text{ }^\circ\text{C}$ ; see <a href="#">Figure 7</a> and <a href="#">8</a>   | -   | -    | 3.5 | V             |
|                                |                                  | $I_D = 1 \text{ mA}; V_{DS} = V_{GS}; T_j = 25 \text{ }^\circ\text{C}$ ; see <a href="#">Figure 7</a> and <a href="#">8</a>  | 1   | 2    | 3.3 | V             |
| $I_{DSS}$                      | drain leakage current            | $V_{DS} = 48 \text{ V}; V_{GS} = 0 \text{ V}; T_j = 25 \text{ }^\circ\text{C}$   | -   | -    | 1   | $\mu\text{A}$ |
|                                |                                  | $V_{DS} = 48 \text{ V}; V_{GS} = 0 \text{ V}; T_j = 150 \text{ }^\circ\text{C}$  | -   | -    | 10  | $\mu\text{A}$ |
| $I_{GSS}$                      | gate leakage current             | $V_{GS} = -10 \text{ V}; V_{DS} = 0 \text{ V}; T_j = 25 \text{ }^\circ\text{C}$  | -   | 50   | 500 | nA            |
|                                |                                  | $V_{GS} = 10 \text{ V}; V_{DS} = 0 \text{ V}; T_j = 25 \text{ }^\circ\text{C}$   | -   | 50   | 500 | nA            |
| $R_{DS(on)}$                   | drain-source on-state resistance | $V_{GS} = 10 \text{ V}; I_D = 500 \text{ mA}; T_j = 150 \text{ }^\circ\text{C}$ ; see <a href="#">Figure 9</a> and <a href="#">10</a>                                    | -   | 5.2  | 8.4 | $\Omega$      |
|                                |                                  | $V_{GS} = 4.5 \text{ V}; I_D = 200 \text{ mA}; T_j = 25 \text{ }^\circ\text{C}$ ; see <a href="#">Figure 9</a> and <a href="#">10</a>                                    | -   | 3.8  | 5.3 | $\Omega$      |
|                                |                                  | $V_{GS} = 10 \text{ V}; I_D = 500 \text{ mA}; T_j = 25 \text{ }^\circ\text{C}$ ; see <a href="#">Figure 9</a> and <a href="#">10</a>                                     | -   | 2.8  | 4.5 | $\Omega$      |
| $V_{(BR)GSS}$                  | gate-source breakdown voltage    | $V_{DS} = 0 \text{ V}; T_j = 25 \text{ }^\circ\text{C}; I_G = -1 \text{ mA}$   | 16  | 22   | -   | V             |
|                                |                                  | $T_j = 25 \text{ }^\circ\text{C}; I_G = 1 \text{ mA}; V_{DS} = 0 \text{ V}$  | 16  | 22   | -   | V             |
| <b>Dynamic characteristics</b> |                                  |  |     |      |     |               |
| $Q_{G(tot)}$                   | total gate charge                | $I_D = 0.5 \text{ A}; V_{DS} = 48 \text{ V}; V_{GS} = 10 \text{ V}; T_j = 25 \text{ }^\circ\text{C}$ ; see <a href="#">Figure 11</a>                                     | -   | 0.85 | -   | nC            |
| $Q_{GS}$                       | gate-source charge               |  | -   | 0.55 | -   | nC            |
| $Q_{GD}$                       | gate-drain charge                |  | -   | 0.07 | -   | nC            |
| $C_{iss}$                      | input capacitance                | $V_{DS} = 10 \text{ V}; V_{GS} = 0 \text{ V}; f = 1 \text{ MHz}; T_j = 25 \text{ }^\circ\text{C}$ ; see <a href="#">Figure 12</a>  | -   | 13   | 40  | pF            |
| $C_{oss}$                      | output capacitance               |  | -   | 8    | 30  | pF            |
| $C_{rss}$                      | reverse transfer capacitance     |  | -   | 4    | 10  | pF            |
| $t_{d(on)}$                    | turn-on delay time               | $V_{DS} = 50 \text{ V}; R_L = 250 \text{ } \Omega; V_{GS} = 10 \text{ V}; R_{G(ext)} = 50 \text{ } \Omega$   | -   | -    | -   | ns            |
| $t_r$                          | rise time                        |  | -   | -    | -   | ns            |
| $t_{d(off)}$                   | turn-off delay time              |  | -   | -    | -   | ns            |
| $t_f$                          | fall time                        |  | -   | -    | -   | ns            |
| $t_{off}$                      | turn-off time                    | $V_{DS} = 50 \text{ V}; V_{GS} = 10 \text{ V}; R_{G(ext)} = 50 \text{ } \Omega; R_{GS} = 50 \text{ } \Omega; T_j = 25 \text{ }^\circ\text{C}; R_L = 250 \text{ } \Omega$ | -   | 9    | -   | ns            |
| $t_{on}$                       | turn-on time                     |  | -   | 3    | -   | ns            |
| <b>Source-drain diode</b>      |                                  |  |     |      |     |               |
| $V_{SD}$                       | source-drain voltage             | $I_S = 300 \text{ mA}; V_{GS} = 0 \text{ V}; T_j = 25 \text{ }^\circ\text{C}$ ; see <a href="#">Figure 13</a>  | -   | 0.93 | 1.5 | V             |
| $t_{rr}$                       | reverse recovery time            | $I_S = 300 \text{ mA}; di_S/dt = -100 \text{ A}/\mu\text{s}; V_{GS} = 0 \text{ V}; V_{DS} = 25 \text{ V}; T_j = 25 \text{ }^\circ\text{C}$                               | -   | 30   | -   | ns            |
| $Q_r$                          | recovered charge                 |  | -   | 30   | -   | nC            |



$T_j = 25\text{ }^\circ\text{C}$

Fig 5. Output characteristics: drain current as a function of drain-source voltage; typical values

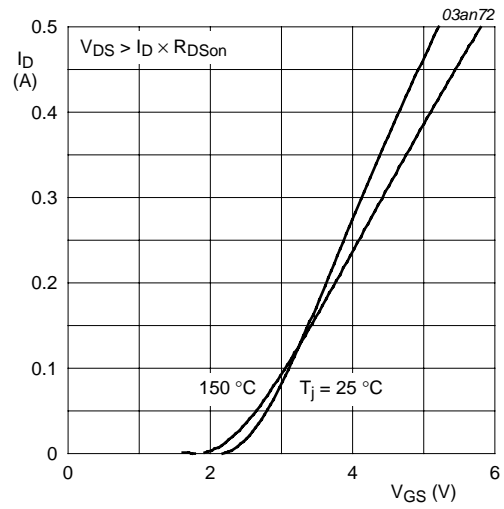

$V_{DS} > I_D \times R_{DSon}$

Fig 6. Transfer characteristics: drain current as a function of gate-source voltage; typical values

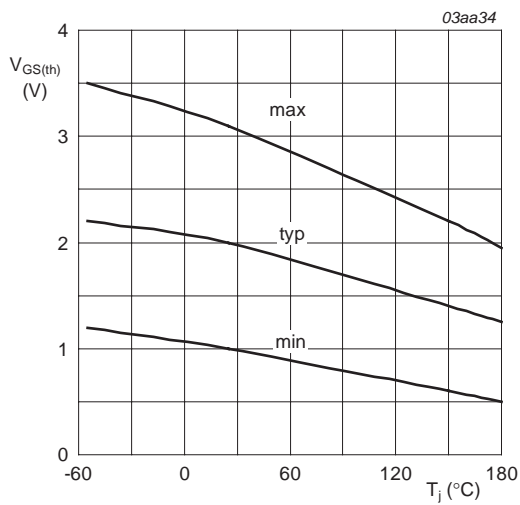

$I_D = 1\text{ mA}; V_{DS} = V_{GS}$

Fig 7. Gate-source threshold voltage as a function of junction temperature

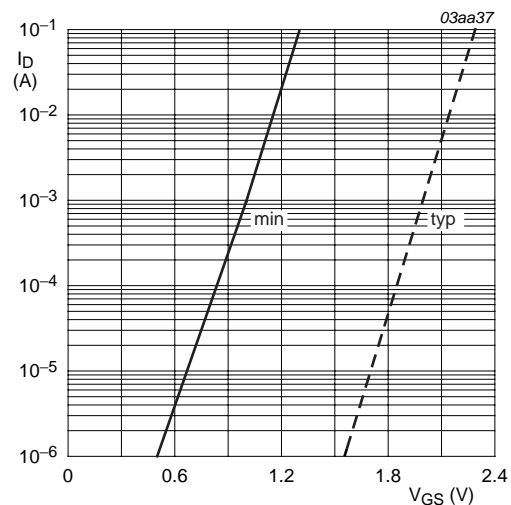

$T_j = 25\text{ }^\circ\text{C}; V_{DS} = 5\text{ V}$

Fig 8. Sub-threshold drain current as a function of gate-source voltage

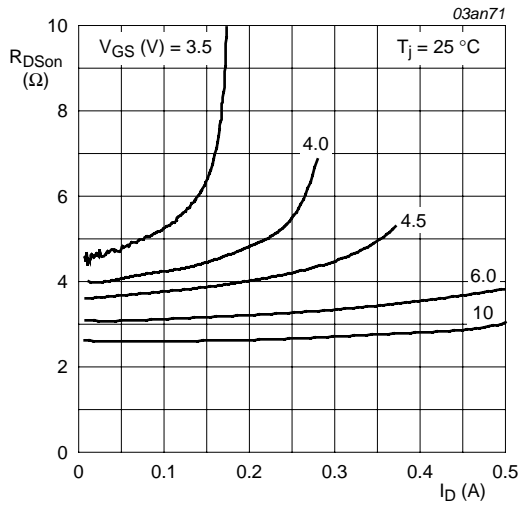

$T_j = 25^\circ C$

Fig 9. Drain-source on-state resistance as a function of drain current; typical values

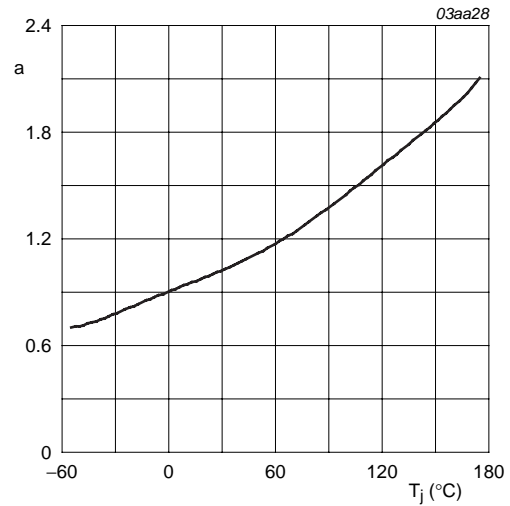

$$a = \frac{R_{DSon}}{R_{DSon(25^\circ C)}}$$

Fig 10. Normalized drain-source on-state resistance factor as a function of junction temperature

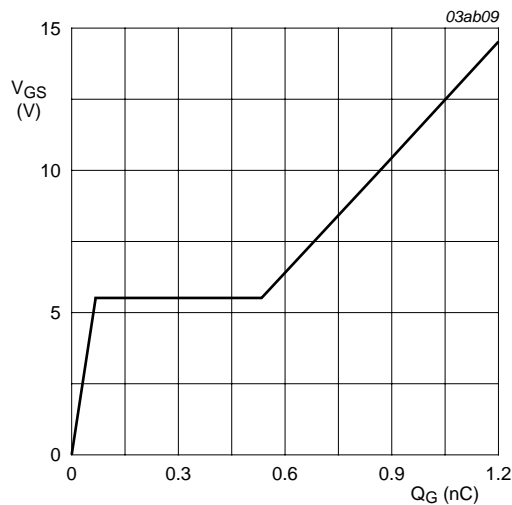

$I_D = 0.5 A; V_{DS} = 48 V$

Fig 11. Gate-source voltage as a function of gate charge; typical values

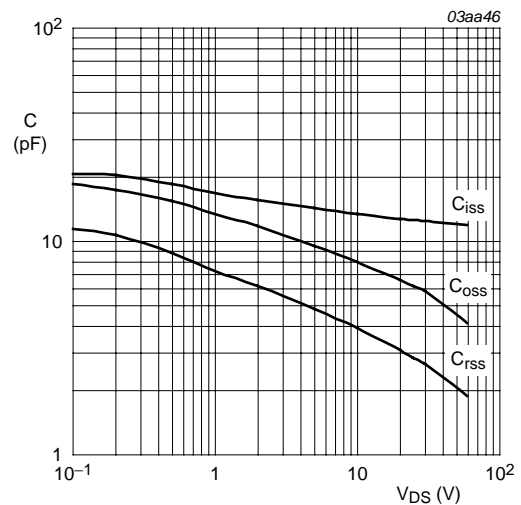

$V_{GS} = 0 V; f = 1 MHz$

Fig 12. Input, output and reverse transfer capacitances as a function of drain-source voltage; typical values

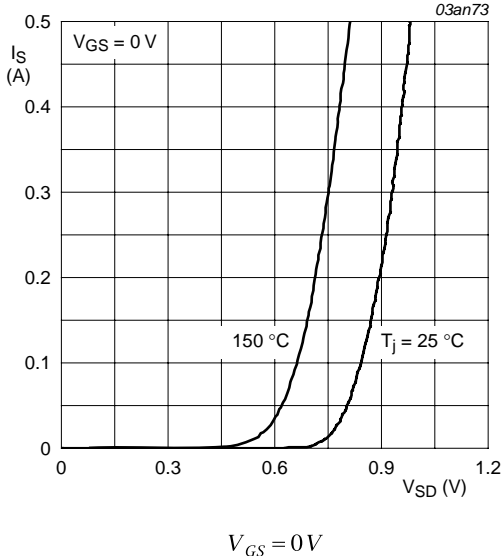

Fig 13. Source current as a function of source-drain voltage; typical values



8. Package outline

Plastic surface-mounted package; 3 leads

SOT323

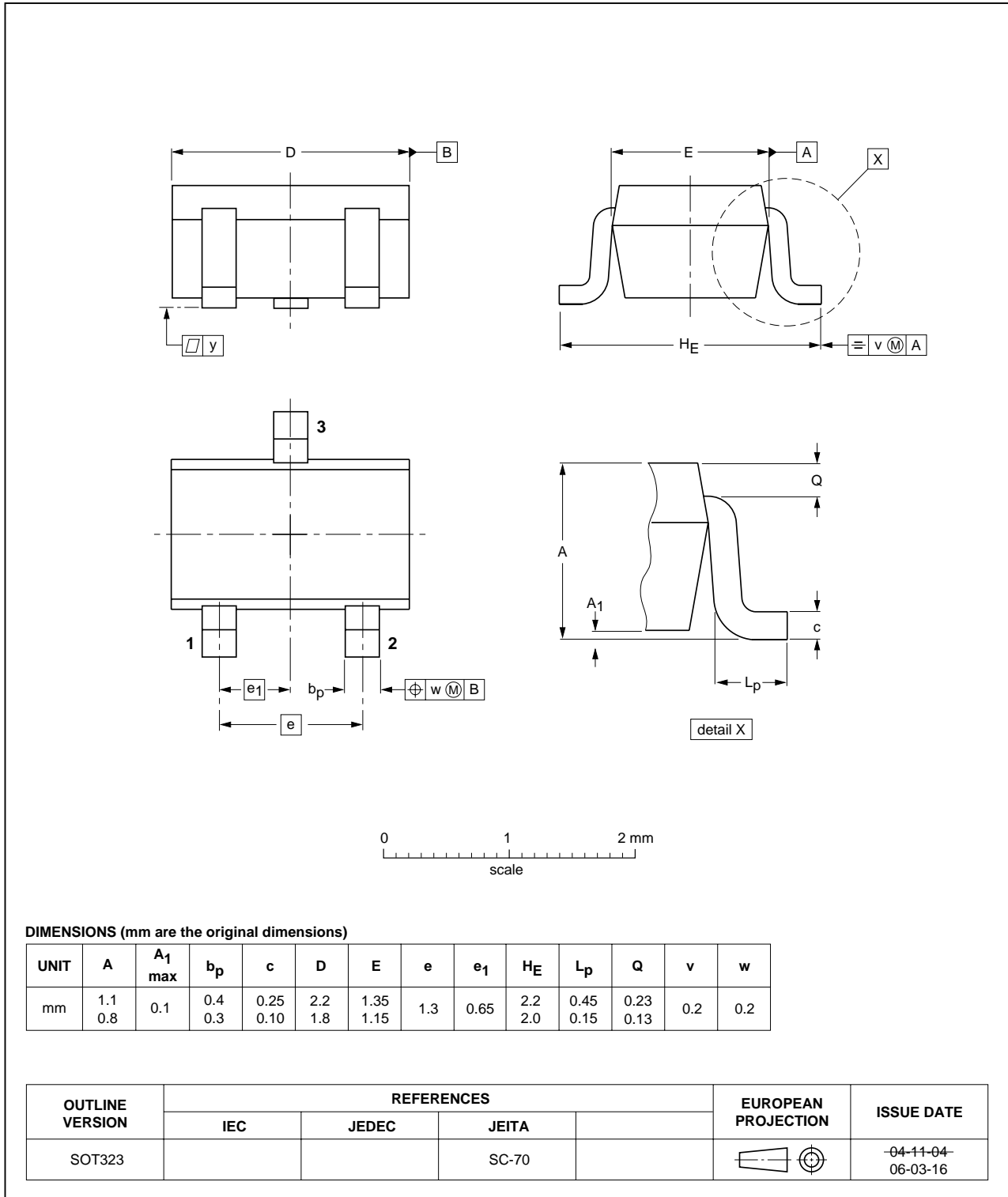

Fig 14. Package outline SOT323 (SC-70)

## 9. Revision history

**Table 8. Revision history**

| Document ID                  | Release date   | Data sheet status  | Change notice | Supersedes  |
|------------------------------|--|--------------------|---------------|-------------|
| PMF3800SN_3                  | 20091111   | Product data sheet | -             | PMF3800SN_2 |
| Modifications:               | <ul style="list-style-type: none"> <li>• The format of this data sheet has been redesigned to comply with the new identity guidelines of NXP Semiconductors.</li> <li>• Legal texts have been adapted to the new company name where appropriate.</li> <li>• Maximum value added for <math>V_{GS(th)}</math> @ <math>T_j = 25\text{ °C}</math> in Characteristics table.</li> </ul> |                    |               |             |
| PMF3800SN_2 (9397 750 15218) | 20050701   | Product data sheet | -             | PMF3800SN_1 |
| PMF3800SN_1 (9397 750 14255) | 20050208   | Product data sheet | -             | -           |

## 10. Legal information

### 10.1 Data sheet status

| Document status <sup>[1][2]</sup> | Product status <sup>[3]</sup> | Definition  |
|-----------------------------------|-------------------------------|---|
| Objective [short] data sheet      | Development                   | This document contains data from the objective specification for product development. |
| Preliminary [short] data sheet    | Qualification                 | This document contains data from the preliminary specification.                       |
| Product [short] data sheet        | Production                    | This document contains the product specification.                                     |

[1] Please consult the most recently issued document before initiating or completing a design.

[2] The term 'short data sheet' is explained in section "Definitions".

[3] The product status of device(s) described in this document may have changed since this document was published and may differ in case of multiple devices. The latest product status information is available on the Internet at URL <http://www.nxp.com>.

### 10.2 Definitions

**Draft** — The document is a draft version only. The content is still under internal review and subject to formal approval, which may result in modifications or additions. NXP Semiconductors does not give any representations or warranties as to the accuracy or completeness of information included herein and shall have no liability for the consequences of use of such information.

**Short data sheet** — A short data sheet is an extract from a full data sheet with the same product type number(s) and title. A short data sheet is intended for quick reference only and should not be relied upon to contain detailed and full information. For detailed and full information see the relevant full data sheet, which is available on request via the local NXP Semiconductors sales office. In case of any inconsistency or conflict with the short data sheet, the full data sheet shall prevail.

### 10.3 Disclaimers

**General** — Information in this document is believed to be accurate and reliable. However, NXP Semiconductors does not give any representations or warranties, expressed or implied, as to the accuracy or completeness of such information and shall have no liability for the consequences of use of such information.

**Right to make changes** — NXP Semiconductors reserves the right to make changes to information published in this document, including without limitation specifications and product descriptions, at any time and without notice. This document supersedes and replaces all information supplied prior to the publication hereof.

**Suitability for use** — NXP Semiconductors products are not designed, authorized or warranted to be suitable for use in medical, military, aircraft, space or life support equipment, nor in applications where failure or malfunction of an NXP Semiconductors product can reasonably be expected to result in personal injury, death or severe property or environmental damage. NXP Semiconductors accepts no liability for inclusion and/or use of NXP Semiconductors products in such equipment or applications and therefore such inclusion and/or use is at the customer's own risk.

**Applications** — Applications that are described herein for any of these products are for illustrative purposes only. NXP Semiconductors makes no representation or warranty that such applications will be suitable for the specified use without further testing or modification.

**Quick reference data** — The Quick reference data is an extract of the product data given in the Limiting values and Characteristics sections of this document, and as such is not complete, exhaustive or legally binding.

**Limiting values** — Stress above one or more limiting values (as defined in the Absolute Maximum Ratings System of IEC 60134) may cause permanent damage to the device. Limiting values are stress ratings only and operation of the device at these or any other conditions above those given in the Characteristics sections of this document is not implied. Exposure to limiting values for extended periods may affect device reliability.

**Terms and conditions of sale** — NXP Semiconductors products are sold subject to the general terms and conditions of commercial sale, as published at <http://www.nxp.com/profile/terms>, including those pertaining to warranty, intellectual property rights infringement and limitation of liability, unless explicitly otherwise agreed to in writing by NXP Semiconductors. In case of any inconsistency or conflict between information in this document and such terms and conditions, the latter will prevail.

**No offer to sell or license** — Nothing in this document may be interpreted or construed as an offer to sell products that is open for acceptance or the grant, conveyance or implication of any license under any copyrights, patents or other industrial or intellectual property rights.

**Export control** — This document as well as the item(s) described herein may be subject to export control regulations. Export might require a prior authorization from national authorities.

### 10.4 Trademarks

Notice: All referenced brands, product names, service names and trademarks are the property of their respective owners.

**TrenchMOS** — is a trademark of NXP B.V.

## 11. Contact information

For more information, please visit: <http://www.nxp.com>

For sales office addresses, please send an email to: [salesaddresses@nxp.com](mailto:salesaddresses@nxp.com)

## 12. Contents

|           |  |           |
|-----------|--|-----------|
| <b>1</b>  | <b>Product profile</b> . . . . .         | <b>1</b>  |
| 1.1       | General description . . . . .            | 1         |
| 1.2       | Features and benefits . . . . .          | 1         |
| 1.3       | Applications . . . . .                   | 1         |
| 1.4       | Quick reference data . . . . .           | 1         |
| <b>2</b>  | <b>Pinning information</b> . . . . .     | <b>2</b>  |
| <b>3</b>  | <b>Ordering information</b> . . . . .    | <b>2</b>  |
| <b>4</b>  | <b>Marking</b> . . . . .                 | <b>2</b>  |
| <b>5</b>  | <b>Limiting values</b> . . . . .         | <b>2</b>  |
| <b>6</b>  | <b>Thermal characteristics</b> . . . . . | <b>4</b>  |
| <b>7</b>  | <b>Characteristics</b> . . . . .         | <b>5</b>  |
| <b>8</b>  | <b>Package outline</b> . . . . .         | <b>9</b>  |
| <b>9</b>  | <b>Revision history</b> . . . . .        | <b>10</b> |
| <b>10</b> | <b>Legal information</b> . . . . .       | <b>11</b> |
| 10.1      | Data sheet status . . . . .              | 11        |
| 10.2      | Definitions . . . . .                    | 11        |
| 10.3      | Disclaimers . . . . .                    | 11        |
| 10.4      | Trademarks . . . . .                     | 11        |
| <b>11</b> | <b>Contact information</b> . . . . .     | <b>11</b> |

Please be aware that important notices concerning this document and the product(s) described herein, have been included in section 'Legal information'.



© NXP B.V. 2009.

All rights reserved.

For more information, please visit: <http://www.nxp.com>

For sales office addresses, please send an email to: [salesaddresses@nxp.com](mailto:salesaddresses@nxp.com)

Date of release: 11 November 2009

Document identifier: PMF3800SN\_3