

# SKM 100GB125DN

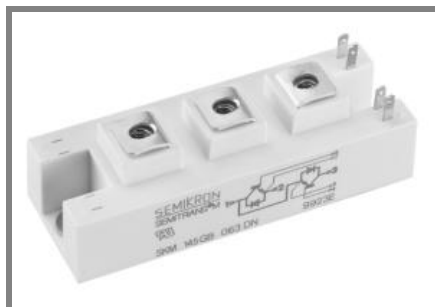

**SEMITRANS® 2N**

## Ultra Fast IGBT Module

**SKM 100GB125DN**

### Features

- N channel, homogeneous Si
- Low inductance case
- Short tail current with low temperature dependence
- High short circuit capability, self limiting to  $6 \times I_{Cnom}$
- Fast & soft inverse CAL diodes
- Isolated copper baseplate using DCB Direct Copper Bonding Technology
- Large clearance (10 mm) and creepage distances (20 mm)

### Typical Applications\*

- Switched mode power supplies at  $f_{sw} > 20$  kHz
- Resonant inverters up to 100 kHz
- Inductive heating
- Electronic welders at  $f_{sw} > 20$  kHz

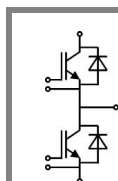

**GB**

Absolute Maximum Ratings		$T_c = 25^\circ\text{C}$ , unless otherwise specified		
Symbol	Conditions	Values		Units
<b>IGBT</b>				
$V_{CES}$	$T_j = 25^\circ\text{C}$	1200		V
$I_C$	$T_j = 150^\circ\text{C}$	$T_{case} = 25^\circ\text{C}$	100	A
		$T_{case} = 85^\circ\text{C}$	80	A
$I_{CRM}$	$I_{CRM} = 2 \times I_{Cnom}$	150		A
$V_{GES}$		$\pm 20$		V
$t_{psc}$	$V_{CC} = 600\text{ V}; V_{GE} \leq 20\text{ V}; T_j = 125^\circ\text{C}$ $V_{CES} < 1200\text{ V}$	10		$\mu\text{s}$
<b>Inverse Diode</b>				
$I_F$	$T_j = 150^\circ\text{C}$	$T_{case} = 25^\circ\text{C}$	95	A
		$T_{case} = 80^\circ\text{C}$	65	A
$I_{FRM}$	$I_{FRM} = 2 \times I_{Fnom}$	150		A
$I_{FSM}$	$t_p = 10\text{ ms}; \text{sin.}$	$T_j = 150^\circ\text{C}$	720	A
<b>Module</b>				
$I_{t(RMS)}$		200		A
$T_{vj}$		- 40 ... + 150		$^\circ\text{C}$
$T_{stg}$		125		$^\circ\text{C}$
$V_{isol}$	AC, 1 min.	4000		V

Characteristics		$T_c = 25^\circ\text{C}$ , unless otherwise specified				
Symbol	Conditions	min.	typ.	max.	Units	
<b>IGBT</b>						
$V_{GE(th)}$	$V_{GE} = V_{CE}, I_C = 2\text{ mA}$	4,5	5,5	6,5	V	
$I_{CES}$	$V_{GE} = 0\text{ V}, V_{CE} = V_{CES}$	$T_j = 25^\circ\text{C}$	0,15		0,45	mA
		$T_j = 125^\circ\text{C}$				mA
$V_{CE0}$		$T_j = 25^\circ\text{C}$			V	
		$T_j = 125^\circ\text{C}$			V	
$r_{CE}$	$V_{GE} = 15\text{ V}$	$T_j = 25^\circ\text{C}$			m $\Omega$	
		$T_j = 125^\circ\text{C}$			m $\Omega$	
$V_{CE(sat)}$	$I_{Cnom} = 75\text{ A}, V_{GE} = 15\text{ V}$	$T_j = ^\circ\text{C}_{chiplev.}$	3,3	3,85	V	
$C_{ies}$	$V_{CE} = 25, V_{GE} = 0\text{ V}$	$f = 1\text{ MHz}$	5		6,6	nF
$C_{oes}$			0,72		0,9	nF
$C_{res}$			0,38		0,5	nF
$Q_G$	$V_{GE} = 0 - +20\text{V}$		650		nC	
$R_{Gint}$	$T_j = ^\circ\text{C}$		5		$\Omega$	
$t_{d(on)}$	$R_{Gon} = 8\ \Omega$	$V_{CC} = 600\text{V}$ $I_C = 75\text{A}$	80		ns	
$t_r$			40		ns	
$E_{on}$			9		mJ	
$t_{d(off)}$	$R_{Goff} = 8\ \Omega$	$T_j = 125^\circ\text{C}$ $V_{GE} = \pm 15\text{V}$	360		ns	
$t_f$			20		ns	
$E_{off}$			3,5		mJ	
$R_{th(j-c)}$	per IGBT		0,18		K/W	

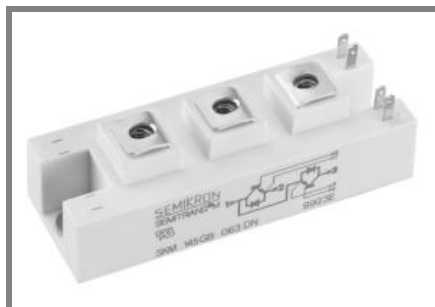

## SEMITRANS® 2N

### Ultra Fast IGBT Module

#### SKM 100GB125DN

#### Features

- N channel, homogeneous Si
- Low inductance case
- Short tail current with low temperature dependence
- High short circuit capability, self limiting to  $6 \times I_{cnom}$
- Fast & soft inverse CAL diodes
- Isolated copper baseplate using DCB Direct Copper Bonding Technology
- Large clearance (10 mm) and creepage distances (20 mm)

#### Typical Applications\*

- Switched mode power supplies at  $f_{sw} > 20$  kHz
- Resonant inverters up to 100 kHz
- Inductive heating
- Electronic welders at  $f_{sw} > 20$  kHz



GB

#### Characteristics

Symbol	Conditions	min.	typ.	max.	Units
<b>Inverse Diode</b>					
$V_F = V_{EC}$	$I_{Fnom} = 75$ A; $V_{GE} = 0$ V		2	2,5	V
			1,8		V
$V_{F0}$			1,1	1,2	V
$r_F$			12	17,3	mΩ
$I_{RRM}$	$I_F = 75$ A		50		A
$Q_{rr}$	$di/dt = 800$ A/μs		11,5		μC
$E_{rr}$	$V_{GE} = 0$ V; $V_{CC} = 600$ V		4		mJ
$R_{th(j-c)D}$	per diode			0,5	K/W
<b>Module</b>					
$L_{CE}$			20	25	nH
$R_{CC'+EE'}$	res., terminal-chip	$T_{case} = 25$ °C	0,75		mΩ
		$T_{case} = 125$ °C	1		mΩ
$R_{th(c-s)}$	per module			0,05	K/W
$M_s$	to heat sink M6		3	5	Nm
$M_t$	to terminals M5		2,5	5	Nm
w				160	g

This is an electrostatic discharge sensitive device (ESDS), international standard IEC 60747-1, Chapter IX.

\* The specifications of our components may not be considered as an assurance of component characteristics. Components have to be tested for the respective application. Adjustments may be necessary. The use of SEMIKRON products in life support appliances and systems is subject to prior specification and written approval by SEMIKRON. We therefore strongly recommend prior consultation of our staff.

# SKM 100GB125DN

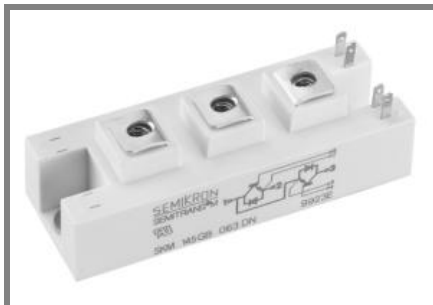

**SEMITRANS® 2N**

**Ultra Fast IGBT Module**

**SKM 100GB125DN**

## Features

- N channel, homogeneous Si
- Low inductance case
- Short tail current with low temperature dependence
- High short circuit capability, self limiting to  $6 \times I_{cnom}$
- Fast & soft inverse CAL diodes
- Isolated copper baseplate using DCB Direct Copper Bonding Technology
- Large clearance (10 mm) and creepage distances (20 mm)

## Typical Applications\*

- Switched mode power supplies at  $f_{sw} > 20$  kHz
- Resonant inverters up to 100 kHz
- Inductive heating
- Electronic welders at  $f_{sw} > 20$  kHz



**GB**

$Z_{th}$			
Symbol	Conditions	Values	Units
$Z_{th(j-c)I}$			
$R_{\theta j-c}$	$i = 1$	95	mk/W
$R_{\theta j-c}$	$i = 2$	65	mk/W
$R_{\theta j-c}$	$i = 3$	17,5	mk/W
$R_{\theta j-c}$	$i = 4$	2,5	mk/W
$\tau_{th(j-c)}$	$i = 1$	0,0327	s
$\tau_{th(j-c)}$	$i = 2$	0,008	s
$\tau_{th(j-c)}$	$i = 3$	0,0017	s
$\tau_{th(j-c)}$	$i = 4$	0,008	s
$Z_{th(j-c)D}$			
$R_{\theta j-c}$	$i = 1$	300	mk/W
$R_{\theta j-c}$	$i = 2$	160	mk/W
$R_{\theta j-c}$	$i = 3$	36	mk/W
$R_{\theta j-c}$	$i = 4$	4	mk/W
$\tau_{th(j-c)}$	$i = 1$	0,054	s
$\tau_{th(j-c)}$	$i = 2$	0,001	s
$\tau_{th(j-c)}$	$i = 3$	0,0015	s
$\tau_{th(j-c)}$	$i = 4$	0,1	s

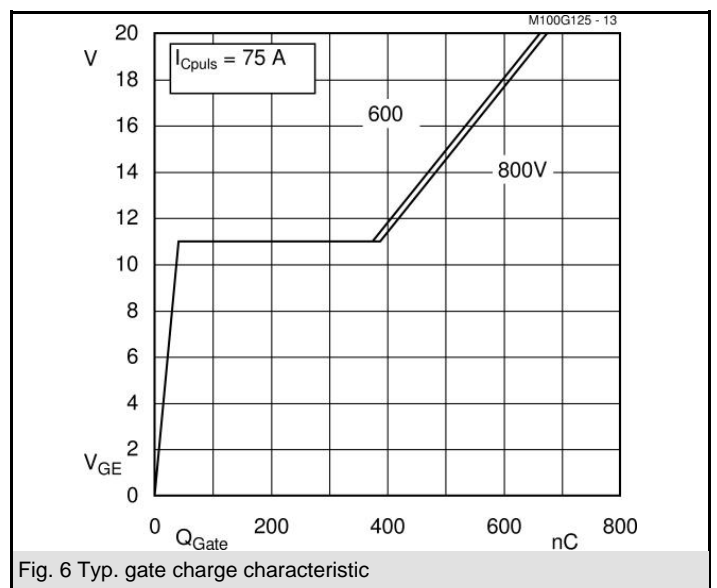
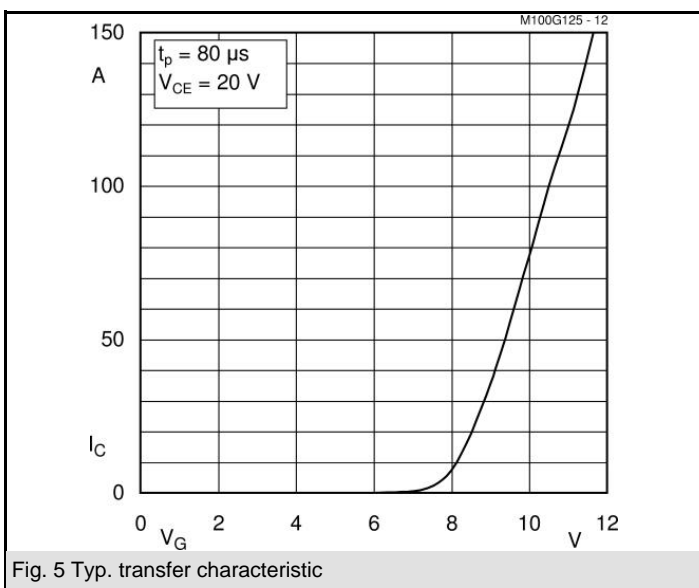
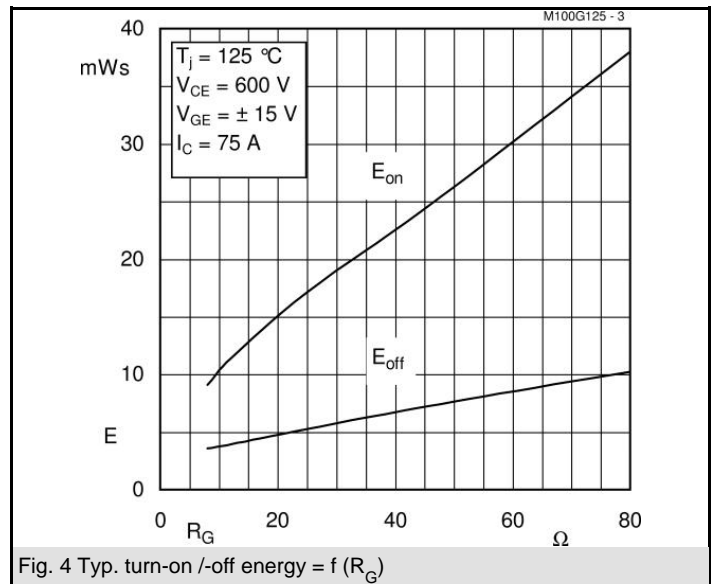
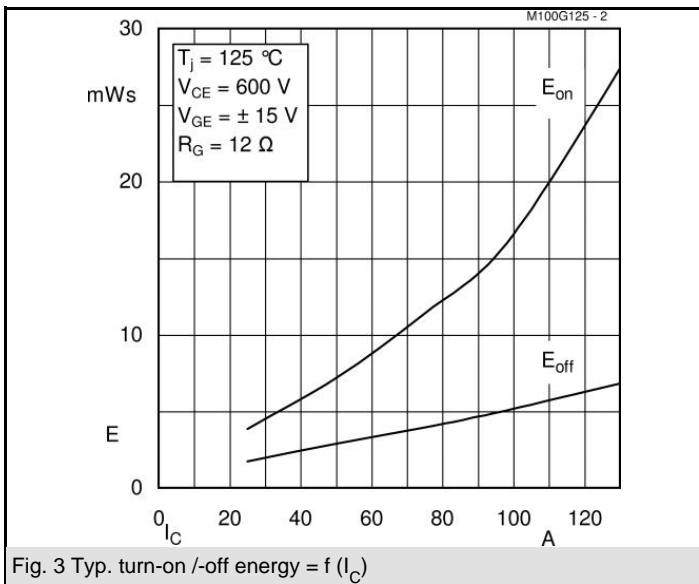
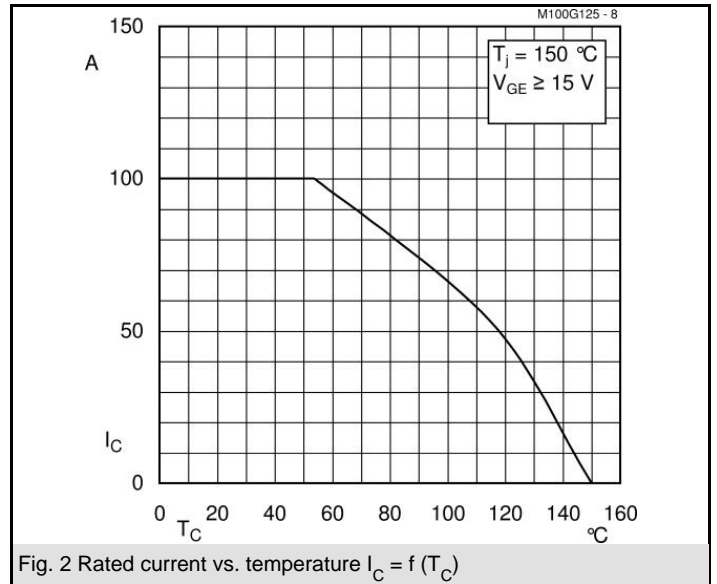
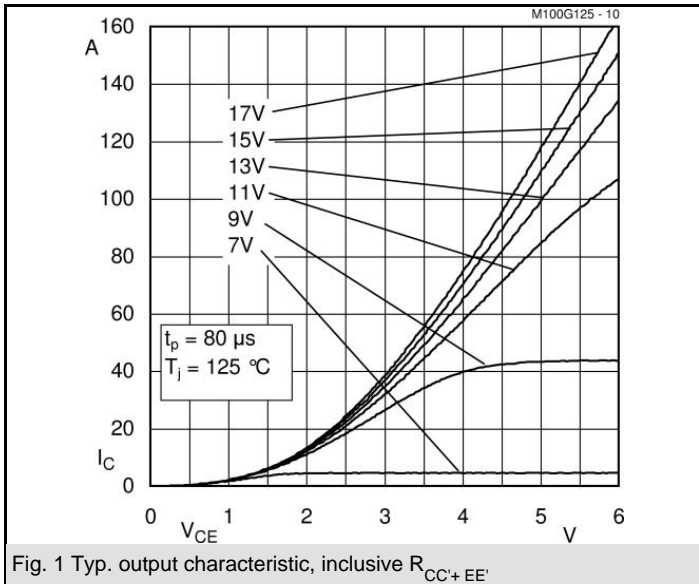

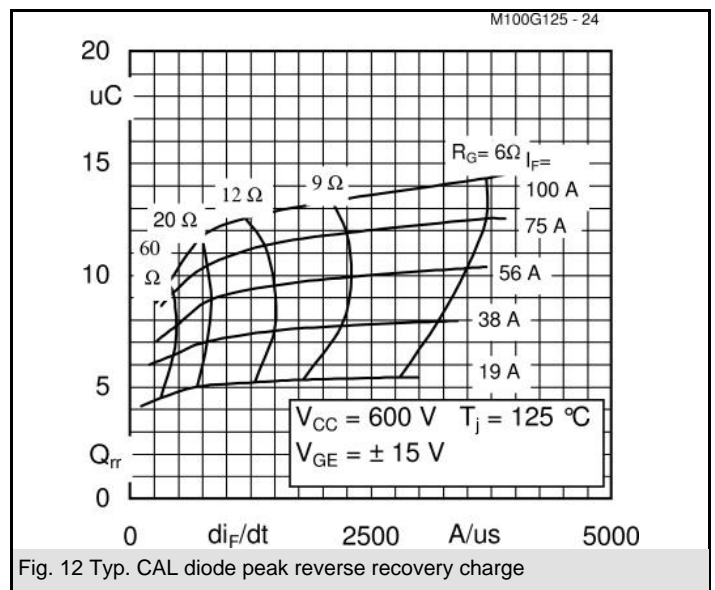
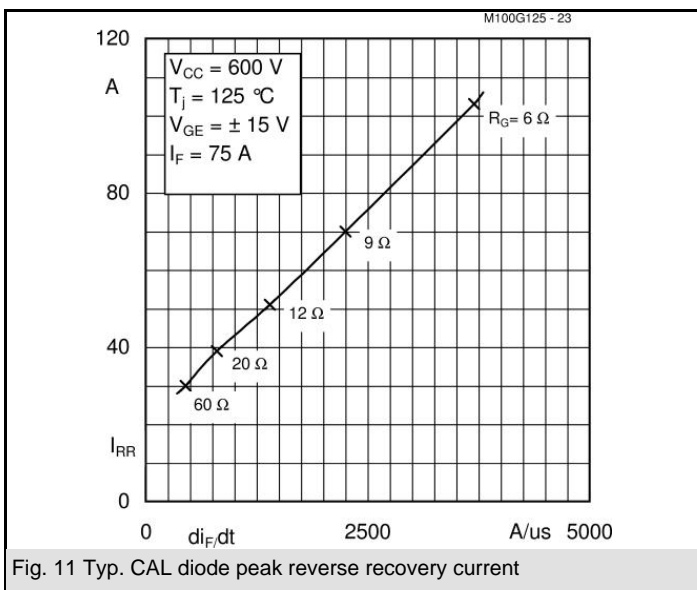
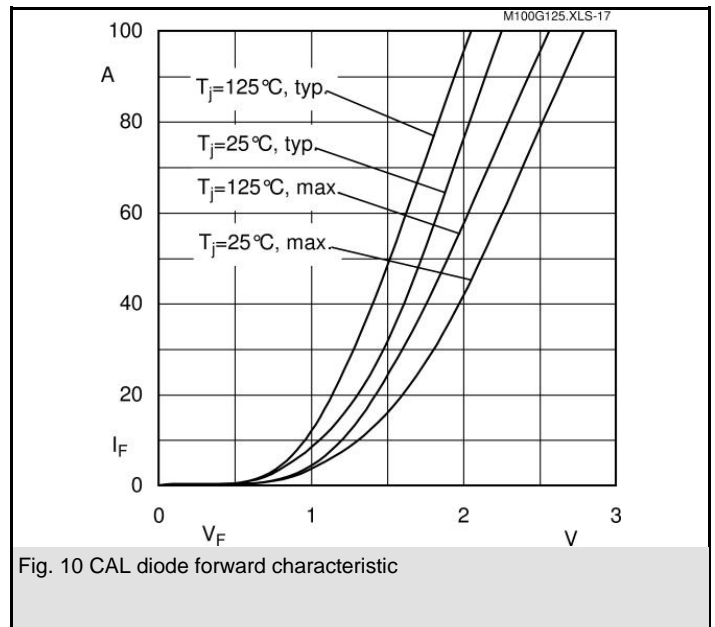
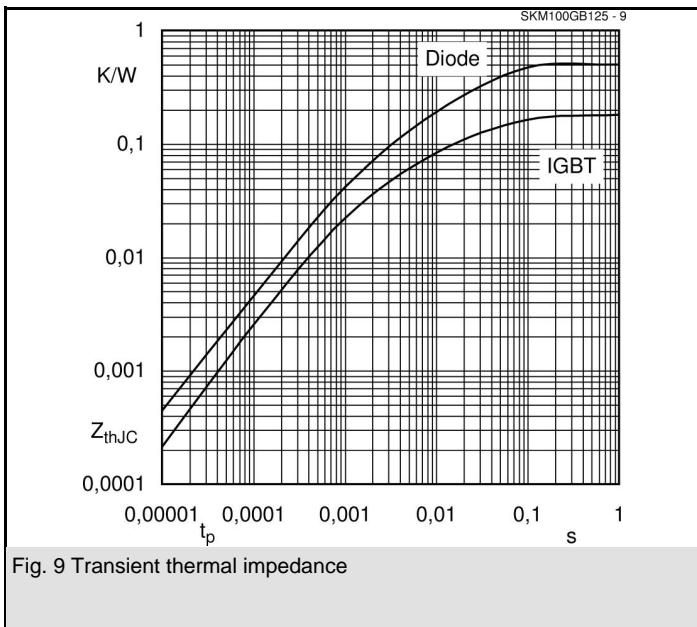
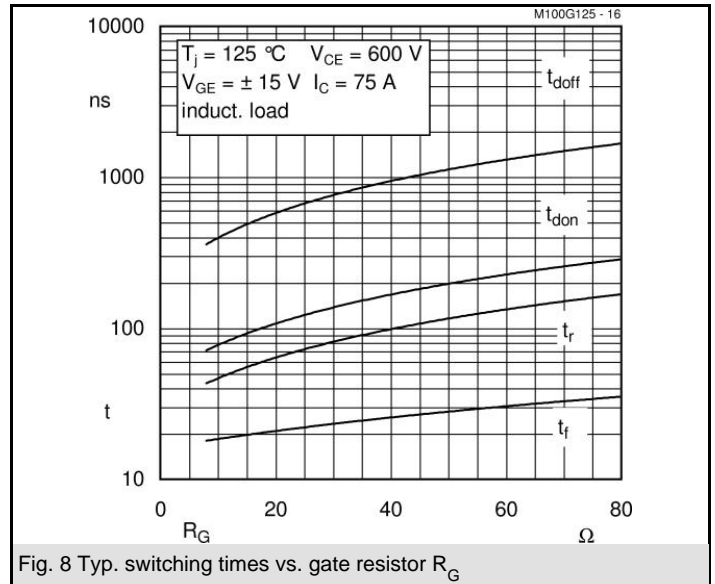
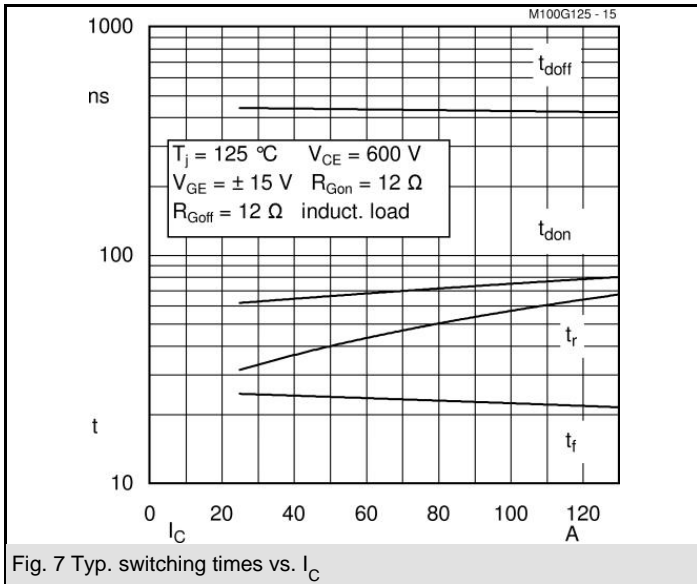

# SKM 100GB125DN

UL Recognized

File 63 532

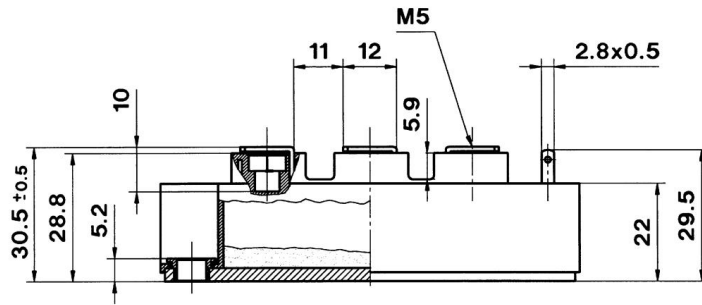

CASED93

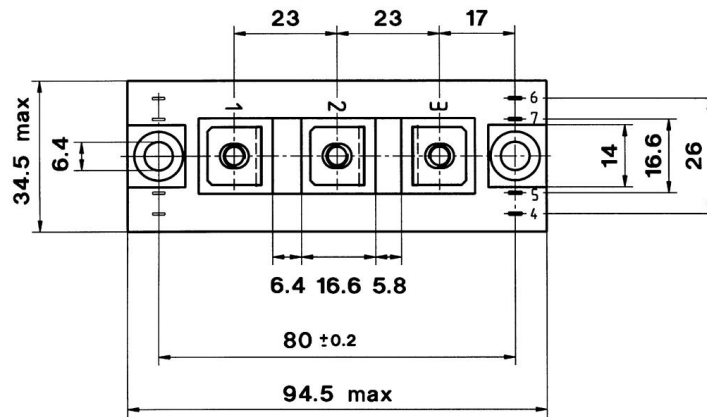

Case D 93

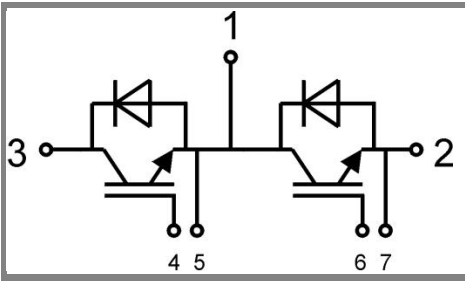

GB

Case D 93