

SKiiP 14NAB065V1

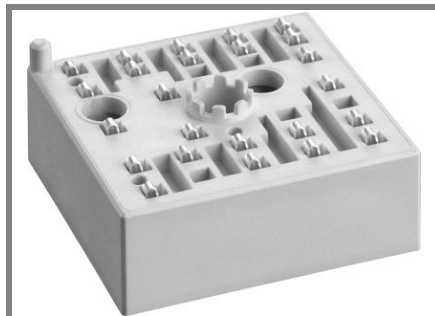

MiniSKiiP® 1

3-phase bridge rectifier +
brake chopper + 3-phase
bridge inverter
SKiiP 14NAB065V1

Features

- Ultrafast NPT IGBTs
- Robust and soft freewheeling diodes in CAL technology
- Highly reliable spring contacts for electrical connections
- UL recognised file no. E63532

Typical Applications*

- Inverter up to 6,3 kVA
- Typical motor power 4,0 kW

Remarks

- V_{CEsat} , V_F = chip level value

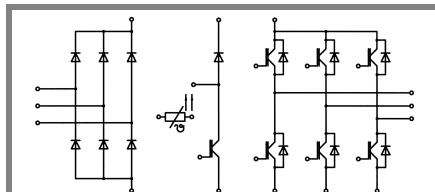

NAB

Absolute Maximum Ratings		$T_s = 25\text{ °C}$, unless otherwise specified		
Symbol	Conditions	Values	Units	
IGBT - Inverter, Chopper				
V_{CES}	$T_s = 25\text{ (70) °C}$	600	V	
I_C		29 (22)	A	
I_{CRM}		40	A	
V_{GES}		± 20	V	
T_j		- 40 ... + 150	°C	
Diode - Inverter, Chopper				
I_F	$T_s = 25\text{ (70) °C}$	26 (19)	A	
I_{FRM}		40	A	
T_j		- 40 ... + 150	°C	
Diode - Rectifier				
V_{RRM}	$T_s = 70\text{ °C}$	800	V	
I_F		46	A	
I_{FSM}		$t_p = 10\text{ ms, sin } 180\text{ °, } T_j = 25\text{ °C}$	370	A
i^2t		$t_p = 10\text{ ms, sin } 180\text{ °, } T_j = 25\text{ °C}$	680	A ² s
T_j		- 40 ... + 150	°C	
Module				
I_{tRMS}	per power terminal (20 A / spring)	20	A	
T_{stg}		- 40 ... + 125	°C	
V_{isol}	AC, 1 min.	2500	V	

Characteristics		$T_s = 25\text{ °C}$, unless otherwise specified			
Symbol	Conditions	min.	typ.	max.	Units
IGBT - Inverter, Chopper					
V_{CEsat}	$I_{Cnom} = 20\text{ A, } T_j = 25\text{ (125) °C}$		2 (2,2)	2,5 (2,7)	V
$V_{GE(th)}$	$V_{GE} = V_{CE}, I_C = 0,5\text{ mA}$	3	4	5	V
$V_{CE(TO)}$	$T_j = 25\text{ (125) °C}$		1,2 (1,1)	1,3 (1,2)	V
r_T	$T_j = 25\text{ (125) °C}$		40 (55)	60 (75)	mΩ
C_{ies}	$V_{CE} = 25\text{ V, } V_{GE} = 0\text{ V, } f = 1\text{ MHz}$		1,1		nF
C_{oes}	$V_{CE} = 25\text{ V, } V_{GE} = 0\text{ V, } f = 1\text{ MHz}$		0,2		nF
C_{res}	$V_{CE} = 25\text{ V, } V_{GE} = 0\text{ V, } f = 1\text{ MHz}$		0,1		nF
$R_{th(j-s)}$	per IGBT		1,25		K/W
$t_{d(on)}$	under following conditions		25		ns
t_r	$V_{CC} = 300\text{ V, } V_{GE} = \pm 15\text{ V}$		30		ns
$t_{d(off)}$	$I_{Cnom} = 20\text{ A, } T_j = 125\text{ °C}$		170		ns
t_f	$R_{Gon} = R_{Goff} = 30\text{ Ω}$		20		ns
E_{on}	inductive load		0,7		mJ
E_{off}			0,4		mJ
Diode - Inverter, Chopper					
$V_F = V_{EC}$	$I_{Fnom} = 20\text{ A, } T_j = 25\text{ (125) °C}$		1,6 (1,6)	1,9 (1,9)	V
$V_{(TO)}$	$T_j = 25\text{ (125) °C}$		1 (0,9)	1,1 (1)	V
r_T	$T_j = 25\text{ (125) °C}$		30 (33)	40 (47)	mΩ
$R_{th(j-s)}$	per diode		2,2		K/W
I_{RRM}	under following conditions		27		A
Q_{rr}	$I_{Fnom} = 20\text{ A, } V_R = 300\text{ V}$		2,3		μC
E_{rr}	$V_{GE} = 0\text{ V, } T_j = 125\text{ °C}$		0,4		mJ
	$di_F/dt = 1350\text{ A/μs}$				
Diode - Rectifier					
V_F	$I_{Fnom} = 25\text{ A, } T_j = 25\text{ °C}$		1,1		V
$V_{(TO)}$	$T_j = 150\text{ °C}$		0,8		V
r_T	$T_j = 150\text{ °C}$		13		mΩ
$R_{th(j-s)}$	per diode		1,25		K/W
Temperature Sensor					
R_{ts}	3 %, $T_r = 25\text{ (100) °C}$		1000(1670)		Ω
Mechanical Data					
w			35		g
M_s	Mounting torque	2		2,5	Nm

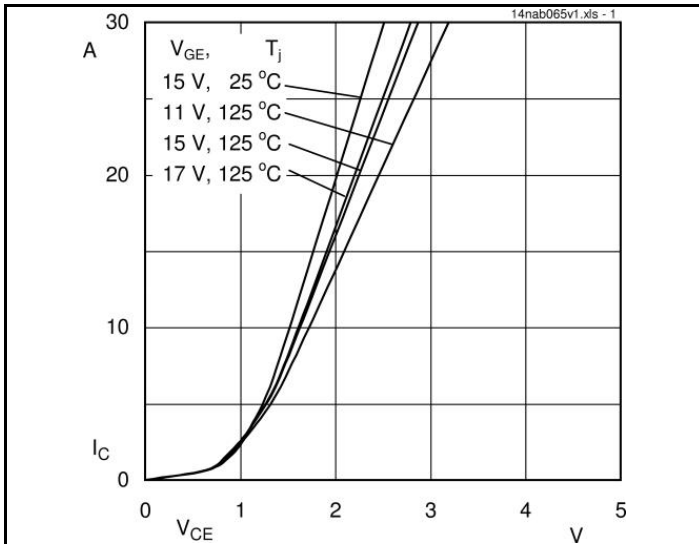

Fig. 1 Typ. output characteristic

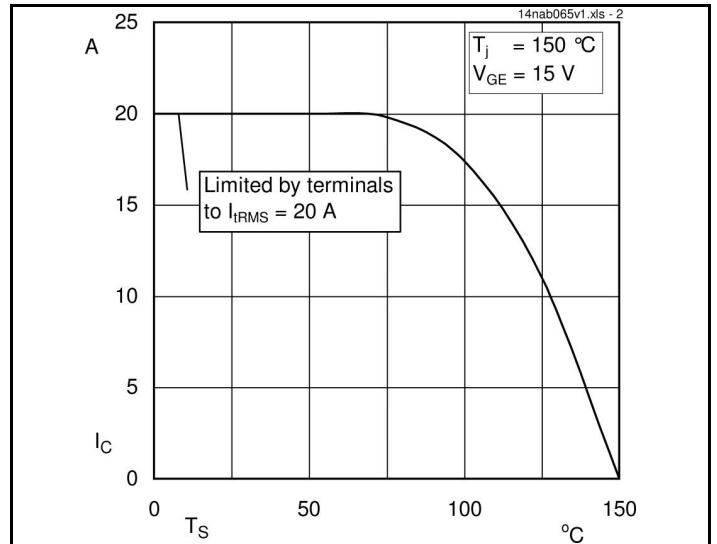

Fig. 2 Typ. rated current vs. temperature

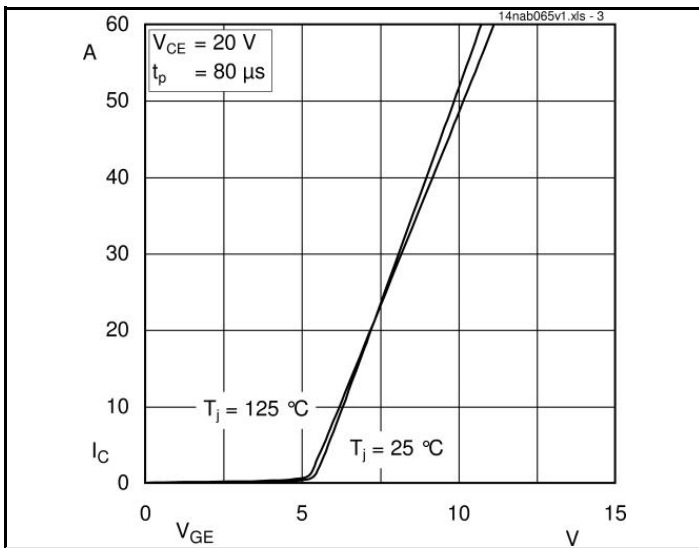

Fig. 3 Typ. transfer characteristic

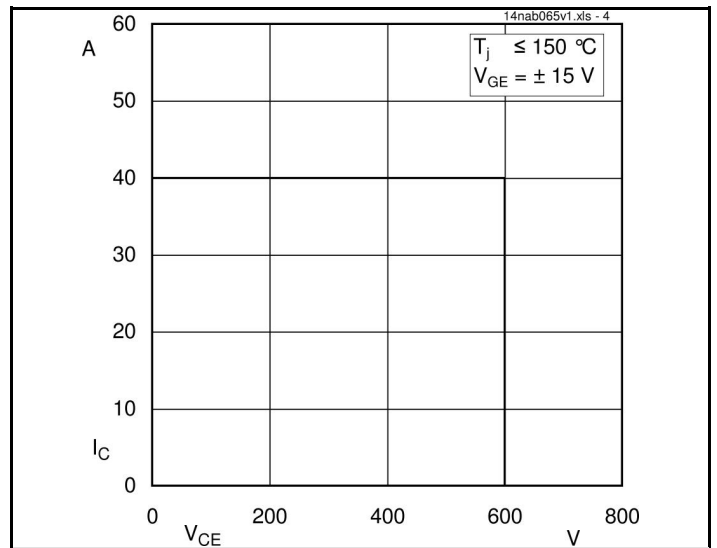

Fig. 4 Reverse bias safe operating area

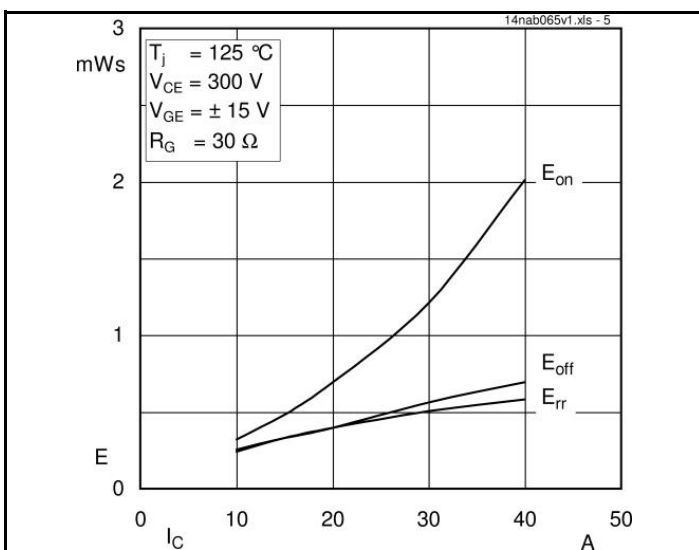

Fig. 5 Typ. Turn-on /-off energy = $f(I_C)$

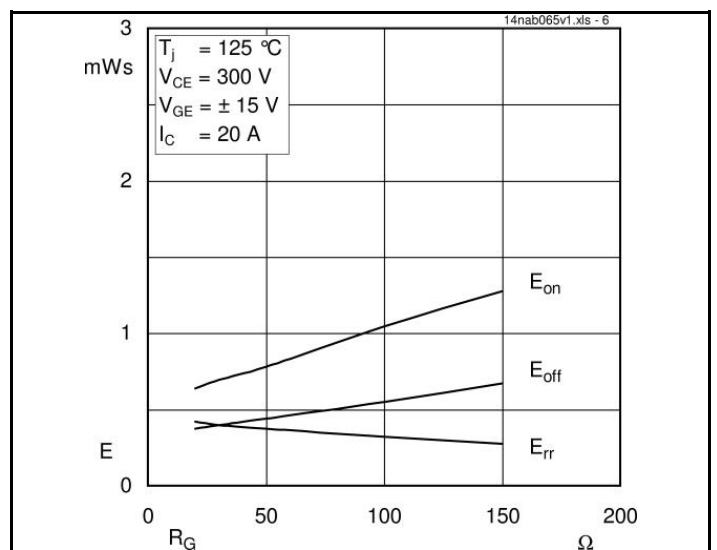

Fig. 6 Typ. Turn-on /-off energy = $f(R_G)$

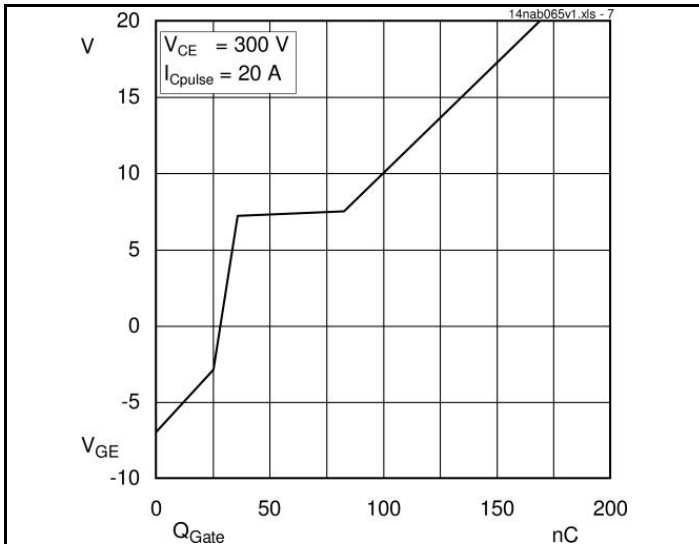

Fig. 7 Typ. gate charge characteristic

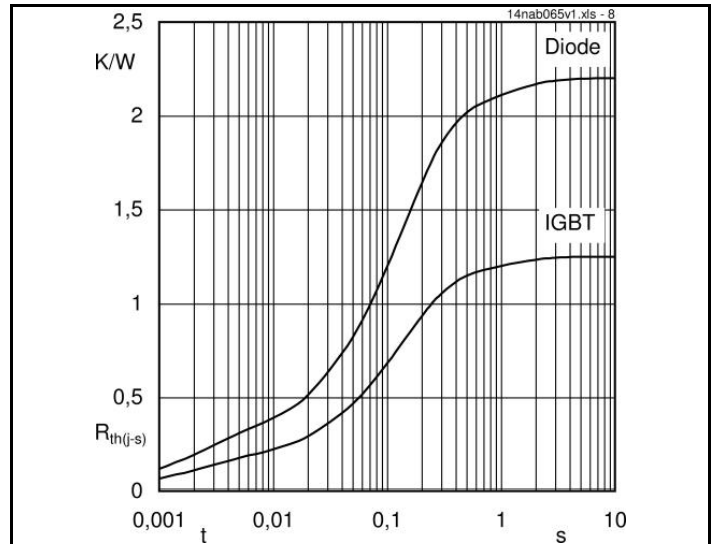

Fig. 8 Typ. thermal impedance

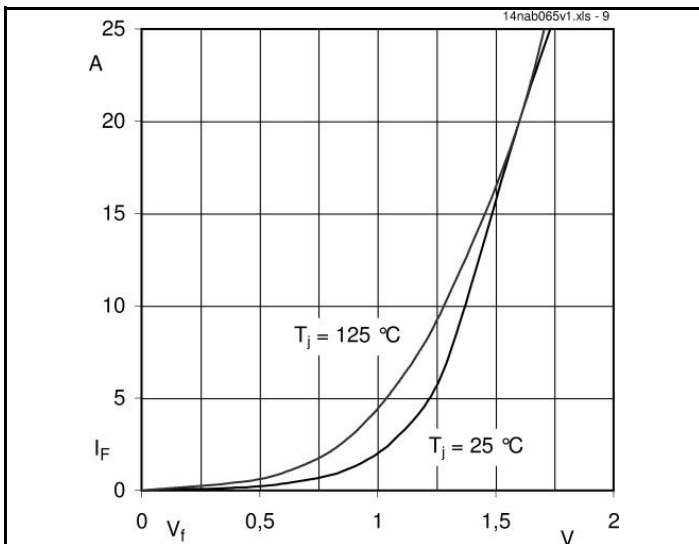

Fig. 9 Typ. freewheeling diode forward characteristic

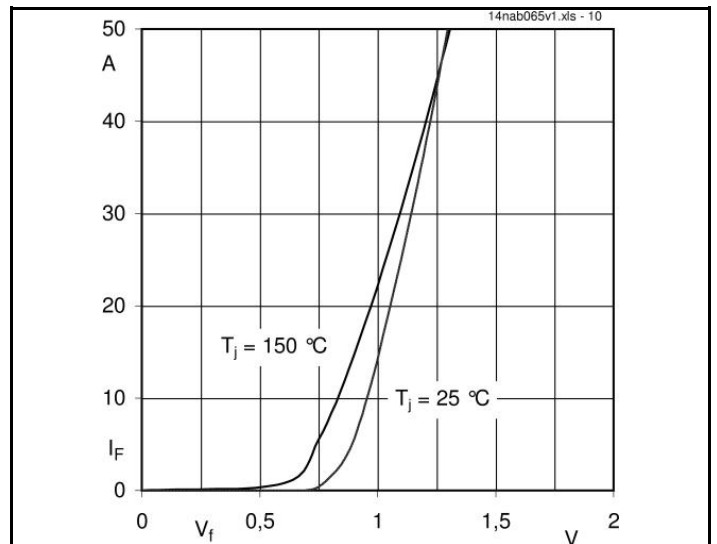
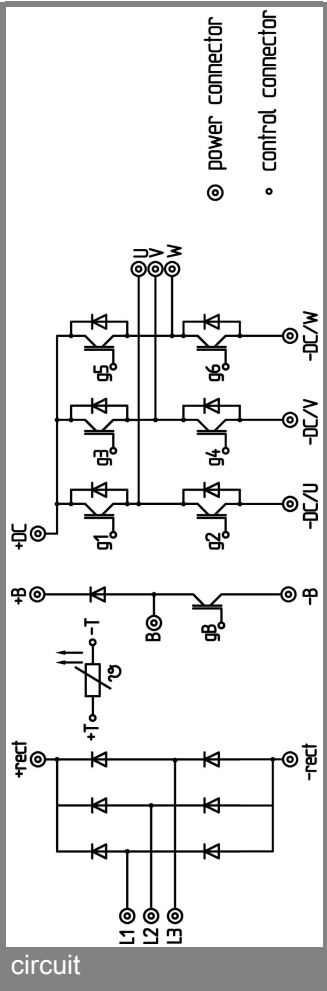
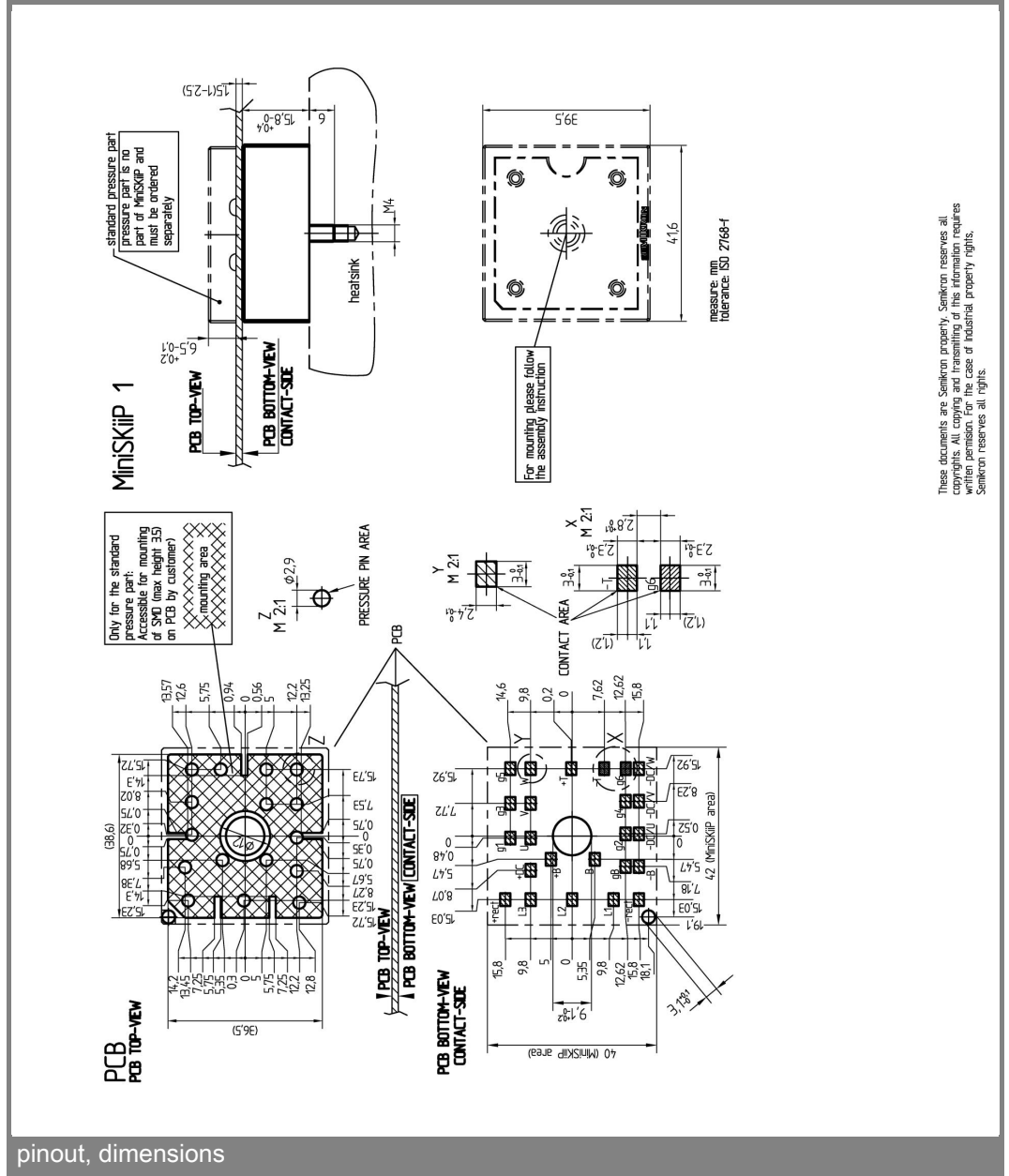

Fig. 10 Typ. input bridge forward characteristic



circuit



pinout, dimensions

These documents are Semikron property. Semikron reserves all copyright and other intellectual property rights. Any reproduction or use without written permission from Semikron is prohibited. Semikron reserves all rights.