

SKiIP 11NAB12T4V1



MiniSKiIP® 1

SKiIP 11NAB12T4V1

Features

- Trench 4 IGBT's
- Robust and soft freewheeling diodes in CAL technology
- Highly reliable spring contacts for electrical connections
- UL recognised file no. E63532

Typical Applications*

- Inverter up to 8 kVA
- Typical motor power 4 kW

Remarks

- V_{CEsat} , V_F = chip level value
- Case temp. limited to $T_C = 125^\circ\text{C}$ max. (for baseplateless modules $T_C = T_S$)
- product rel. results valid for $T_j \leq 150$ (recomm. Top = $-40 \dots +150^\circ\text{C}$)

Absolute Maximum Ratings				
Symbol	Conditions		Values	Unit
Inverter - IGBT				
V_{CES}	$T_j = 25^\circ\text{C}$		1200	V
I_C	$T_j = 150^\circ\text{C}$	$T_s = 25^\circ\text{C}$	12	A
		$T_s = 70^\circ\text{C}$	12	A
I_C	$T_j = 175^\circ\text{C}$	$T_s = 25^\circ\text{C}$	12	A
		$T_s = 70^\circ\text{C}$	12	A
I_{Cnom}			8	A
I_{CRM}	$I_{CRM} = 3 \times I_{Cnom}$		24	A
V_{GES}			-20 ... 20	V
t_{psc}	$V_{CC} = 800\text{ V}$ $V_{GE} \leq 15\text{ V}$ $V_{CES} \leq 1200\text{ V}$	$T_j = 150^\circ\text{C}$	10	μs
T_j			-40 ... 175	$^\circ\text{C}$
Chopper - IGBT				
V_{CES}	$T_j = 25^\circ\text{C}$		1200	V
I_C	$T_j = 150^\circ\text{C}$	$T_s = 25^\circ\text{C}$	12	A
		$T_s = 70^\circ\text{C}$	12	A
I_C	$T_j = 175^\circ\text{C}$	$T_s = 25^\circ\text{C}$	12	A
		$T_s = 70^\circ\text{C}$	12	A
I_{Cnom}			8	A
I_{CRM}	$I_{CRM} = 3 \times I_{Cnom}$		24	A
V_{GES}			-20 ... 20	V
t_{psc}	$V_{CC} = 800\text{ V}$ $V_{GE} \leq 15\text{ V}$ $V_{CES} \leq 1200\text{ V}$	$T_j = 150^\circ\text{C}$	10	μs
T_j			-40 ... 175	$^\circ\text{C}$
Inverse - Diode				
V_{RRM}	$T_j = 25^\circ\text{C}$		1200	V
I_F	$T_j = 150^\circ\text{C}$	$T_s = 25^\circ\text{C}$	14	A
		$T_s = 70^\circ\text{C}$	11	A
I_F	$T_j = 175^\circ\text{C}$	$T_s = 25^\circ\text{C}$	15	A
		$T_s = 70^\circ\text{C}$	12	A
I_{Fnom}			8	A
I_{FRM}	$I_{FRM} = 3 \times I_{Fnom}$		24	A
I_{FSM}	$t_p = 10\text{ ms, sin } 180^\circ, T_j = 150^\circ\text{C}$		36	A
T_j			-40 ... 175	$^\circ\text{C}$
Freewheeling - Diode				
V_{RRM}	$T_j = 25^\circ\text{C}$		1200	V
I_F	$T_j = 150^\circ\text{C}$	$T_s = 25^\circ\text{C}$	14	A
		$T_s = 70^\circ\text{C}$	11	A
I_F	$T_j = 175^\circ\text{C}$	$T_s = 25^\circ\text{C}$	15	A
		$T_s = 70^\circ\text{C}$	12	A
I_{Fnom}			8	A
I_{FRM}	$I_{FRM} = 3 \times I_{Fnom}$		24	A
I_{FSM}	$t_p = 10\text{ ms, sin } 180^\circ, T_j = 150^\circ\text{C}$		36	A
T_j			-40 ... 175	$^\circ\text{C}$

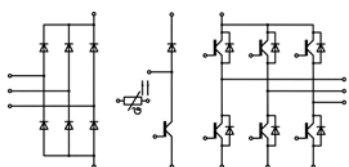

NAB

SKiiP 11NAB12T4V1

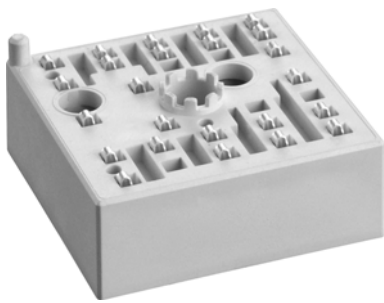

MiniSKiiP® 1

SKiiP 11NAB12T4V1

Features

- Trench 4 IGBT's
- Robust and soft freewheeling diodes in CAL technology
- Highly reliable spring contacts for electrical connections
- UL recognised file no. E63532

Typical Applications*

- Inverter up to 8 kVA
- Typical motor power 4 kW

Remarks

- V_{CEsat} , V_F = chip level value
- Case temp. limited to $T_C = 125^\circ\text{C}$ max. (for baseplateless modules $T_C = T_S$)
- product rel. results valid for $T_j \leq 150$ (recomm. Top = $-40 \dots +150^\circ\text{C}$)

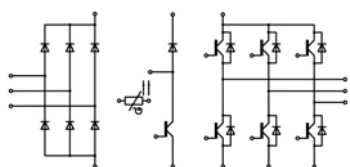

NAB

Absolute Maximum Ratings				
Symbol	Conditions	Values	Unit	
Rectifier - Diode				
V_{RRM}	$T_j = 25^\circ\text{C}$	1600	V	
I_F	$T_s = 25^\circ\text{C}, T_j = 150^\circ\text{C}$	39	A	
I_{Fnom}		8	A	
I_{FSM}	10 ms	$T_j = 25^\circ\text{C}$	220	A
	sin 180°	$T_j = 150^\circ\text{C}$	200	A
I^2t	10 ms	$T_j = 25^\circ\text{C}$	242	A ² s
	sin 180°	$T_j = 150^\circ\text{C}$	200	A ² s
T_j		-40 ... 150	°C	
Module				
$I_t(\text{RMS})$	$T_{\text{terminal}} = 80^\circ\text{C}, 20\text{A per spring}$	20	A	
T_{stg}		-40 ... 125	°C	
V_{isol}	AC sinus 50Hz, 1 min	2500	V	

Characteristics					
Symbol	Conditions	min.	typ.	max.	Unit
Inverter - IGBT					
$V_{CE(\text{sat})}$	$I_C = 8\text{ A}$ $V_{GE} = 15\text{ V}$ chipllevel	$T_j = 25^\circ\text{C}$	1.85	2.10	V
		$T_j = 150^\circ\text{C}$	2.25	2.45	V
V_{CE0}		$T_j = 25^\circ\text{C}$	0.8	0.9	V
		$T_j = 150^\circ\text{C}$	0.7	0.8	V
r_{CE}	$V_{GE} = 15\text{ V}$	$T_j = 25^\circ\text{C}$	131	150	mΩ
		$T_j = 150^\circ\text{C}$	194	206	mΩ
$V_{GE(\text{th})}$	$V_{GE} = V_{CE}\text{ V}, I_C = 1\text{ mA}$	5	5.8	6.5	V
I_{CES}	$V_{GE} = 0\text{ V}$ $V_{CE} = 1200\text{ V}$	$T_j = 25^\circ\text{C}$	0.1	0.3	mA
					mA
C_{ies}	$V_{CE} = 25\text{ V}$ $V_{GE} = 0\text{ V}$	$f = 1\text{ MHz}$	0.49		nF
C_{oes}		$f = 1\text{ MHz}$	0.05		nF
C_{res}		$f = 1\text{ MHz}$	0.03		nF
Q_G	- 8 V...+ 15 V		45		nC
R_{Gint}	$T_j = 25^\circ\text{C}$		0.00		Ω
$t_{d(\text{on})}$	$V_{CC} = 600\text{ V}$	$T_j = 150^\circ\text{C}$	31		ns
t_r	$I_C = 8\text{ A}$	$T_j = 150^\circ\text{C}$	31		ns
E_{on}	$R_{G\text{ on}} = 47\ \Omega$	$T_j = 150^\circ\text{C}$	0.87		mJ
$t_{d(\text{off})}$	$R_{G\text{ off}} = 47\ \Omega$	$T_j = 150^\circ\text{C}$	290		ns
t_f		$T_j = 150^\circ\text{C}$	70		ns
E_{off}	$V_{GE} = +15/-15\text{ V}$	$T_j = 150^\circ\text{C}$	0.74		mJ
$R_{\text{th}(j-s)}$	per IGBT		1.84		K/W
Chopper - IGBT					
$V_{CE(\text{sat})}$	$I_C = 8\text{ A}$ $V_{GE} = 15\text{ V}$ chipllevel	$T_j = 25^\circ\text{C}$	1.85	2.10	V
		$T_j = 150^\circ\text{C}$	2.25	2.45	V
V_{CE0}		$T_j = 25^\circ\text{C}$	0.8	0.9	V
		$T_j = 150^\circ\text{C}$	0.7	0.8	V
r_{CE}	$V_{GE} = 15\text{ V}$	$T_j = 25^\circ\text{C}$	131	150	mΩ
		$T_j = 150^\circ\text{C}$	194	206	mΩ
$V_{GE(\text{th})}$	$V_{GE} = V_{CE}\text{ V}, I_C = 1\text{ mA}$	5	5.8	6.5	V
I_{CES}	$V_{GE} = 0\text{ V}$ $V_{CE} = 1200\text{ V}$	$T_j = 25^\circ\text{C}$	0.1	0.3	mA
		$T_j = 150^\circ\text{C}$			mA
Q_G	- 8 V...+ 15 V		45		nC
R_{Gint}	$T_j = 25^\circ\text{C}$		0.00		Ω

SKiiP 11NAB12T4V1



MiniSKiiP® 1

SKiiP 11NAB12T4V1

Features

- Trench 4 IGBT's
- Robust and soft freewheeling diodes in CAL technology
- Highly reliable spring contacts for electrical connections
- UL recognised file no. E63532

Typical Applications*

- Inverter up to 8 kVA
- Typical motor power 4 kW

Remarks

- V_{CEsat} , V_F = chip level value
- Case temp. limited to $T_C = 125^\circ\text{C}$ max. (for baseplateless modules $T_C = T_S$)
- product rel. results valid for $T_j \leq 150$ (recomm. Top = $-40 \dots +150^\circ\text{C}$)

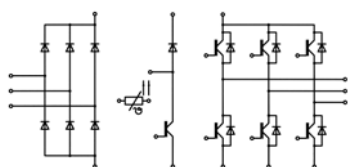

NAB

Characteristics						
Symbol	Conditions		min.	typ.	max.	Unit
Chopper - IGBT						
$t_{d(on)}$	$V_{CC} = 600\text{ V}$	$T_j = 150^\circ\text{C}$		31		ns
t_r	$I_C = 8\text{ A}$	$T_j = 150^\circ\text{C}$		31		ns
E_{on}	$R_{G\ on} = 47\ \Omega$	$T_j = 150^\circ\text{C}$		0.87		mJ
	$R_{G\ off} = 47\ \Omega$	$T_j = 150^\circ\text{C}$		290		ns
$t_{d(off)}$		$T_j = 150^\circ\text{C}$		70		ns
t_f		$T_j = 150^\circ\text{C}$		70		ns
E_{off}	$V_{GE} = +15/-15\text{ V}$	$T_j = 150^\circ\text{C}$		0.74		mJ
$R_{th(j-s)}$	per IGBT			1.84		K/W
Inverse - Diode						
$V_F = V_{EC}$	$I_F = 8\text{ A}$	$T_j = 25^\circ\text{C}$		2.3	2.6	V
	$V_{GE} = 0\text{ V}$ chiplevel	$T_j = 150^\circ\text{C}$		2.4	2.7	V
V_{F0}		$T_j = 25^\circ\text{C}$		1.3	1.5	V
		$T_j = 150^\circ\text{C}$		0.9	1.1	V
r_F		$T_j = 25^\circ\text{C}$		129	144	m Ω
		$T_j = 150^\circ\text{C}$		181	198	m Ω
I_{RRM}	$I_F = 8\text{ A}$	$T_j = 150^\circ\text{C}$		8.3		A
Q_{rr}	$di/dt_{off} = 380\text{ A}/\mu\text{s}$	$T_j = 150^\circ\text{C}$		1.35		μC
E_{rr}	$V_{GE} = -15\text{ V}$ $V_{CC} = 600\text{ V}$	$T_j = 150^\circ\text{C}$		0.57		mJ
$R_{th(j-s)}$	per Diode			2.53		K/W
Freewheeling - Diode						
$V_F = V_{EC}$	$I_F = 8\text{ A}$	$T_j = 25^\circ\text{C}$		2.3	2.6	V
	$V_{GE} = 0\text{ V}$ chiplevel	$T_j = 150^\circ\text{C}$		2.4	2.7	V
V_{F0}		$T_j = 25^\circ\text{C}$		1.3	1.5	V
		$T_j = 150^\circ\text{C}$		0.9	1.1	V
r_F		$T_j = 25^\circ\text{C}$		129	144	m Ω
		$T_j = 150^\circ\text{C}$		181	198	m Ω
I_{RRM}	$I_F = 8\text{ A}$	$T_j = 150^\circ\text{C}$		8.3		A
Q_{rr}	$di/dt_{off} = 380\text{ A}/\mu\text{s}$	$T_j = 150^\circ\text{C}$		1.35		μC
E_{rr}	$V_{GE} = -15\text{ V}$ $V_{CC} = 600\text{ V}$	$T_j = 150^\circ\text{C}$		0.57		mJ
$R_{th(j-s)}$	per Diode			2.53		K/W
Rectifier - Diode						
$V_F = V_{EC}$	$I_F = 8\text{ A}$	$T_j = 25^\circ\text{C}$		1	1.21	V
	$V_{GE} = 0\text{ V}$ chiplevel	$T_j = 125^\circ\text{C}$			1.1	V
V_{F0}		$T_j = 25^\circ\text{C}$			1.0	V
		$T_j = 125^\circ\text{C}$			0.8	V
r_F		$T_j = 25^\circ\text{C}$		15	29	m Ω
		$T_j = 125^\circ\text{C}$			34	m Ω
$R_{th(j-s)}$	per Diode			1.5		K/W
Module						
M_s	to heat sink		2		2.5	Nm
w				35		g
Temperatur Sensor						
R_{100}	$T_r = 100^\circ\text{C}$, tolerance = 3 %			1670 \pm 3%		Ω
$R(T)$	$R(T) = 1000\ \Omega [1 + A(T - 25^\circ\text{C}) + B(T - 25^\circ\text{C})^2]$ $A = 7.635 \cdot 10^{-3}\ \text{C}^{-1}$, $B = 1.731 \cdot 10^{-5}\ \text{C}^{-2}$					

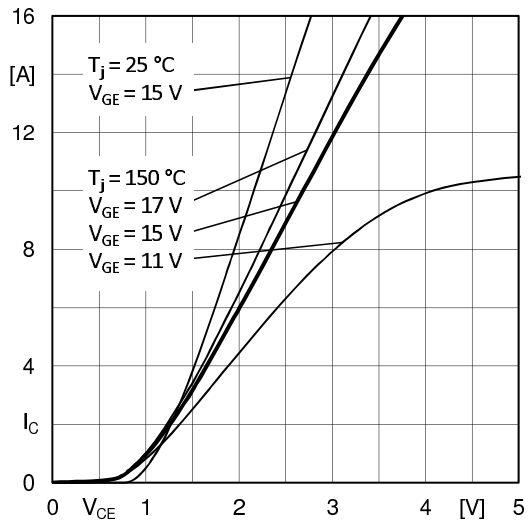

Fig. 1: Typ. output characteristic

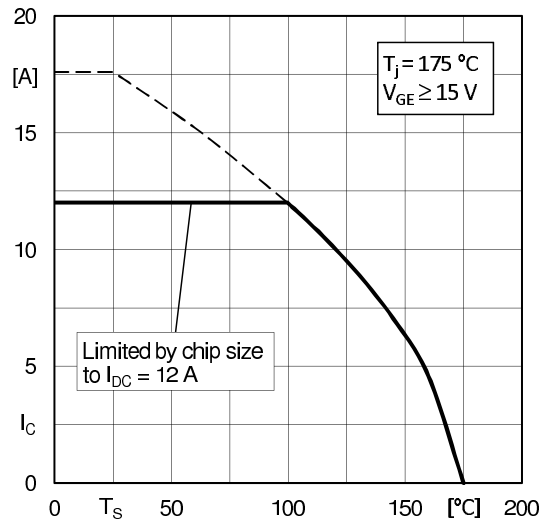

Fig. 2: Typ. rated current vs. temperature $I_C = f(T_S)$

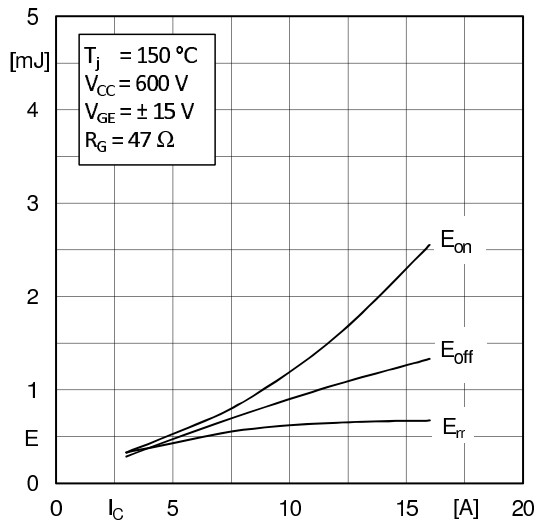

Fig. 3: Typ. turn-on /-off energy = f(Ic)

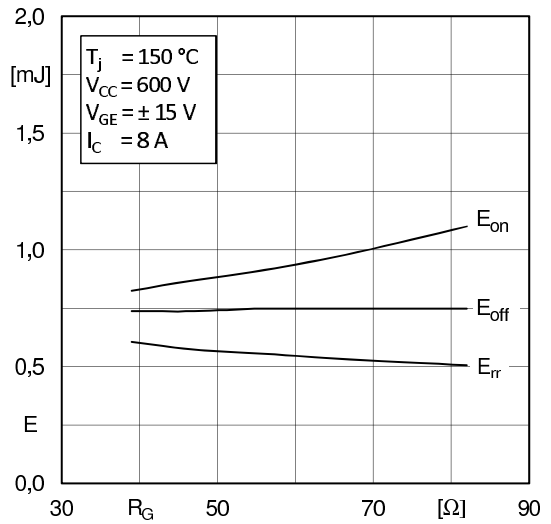

Fig. 4: Typ. turn-on /-off energy = f(RG)

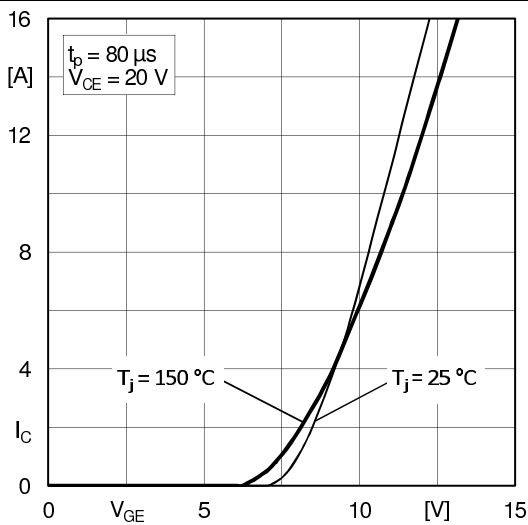

Fig. 5: Typ. transfer characteristic

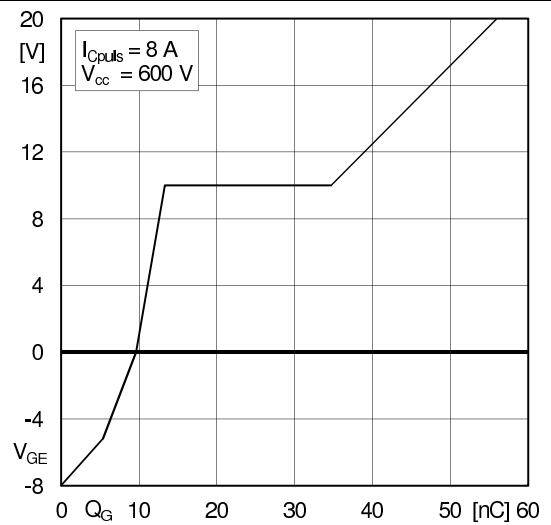

Fig. 6: Typ. gate charge characteristic

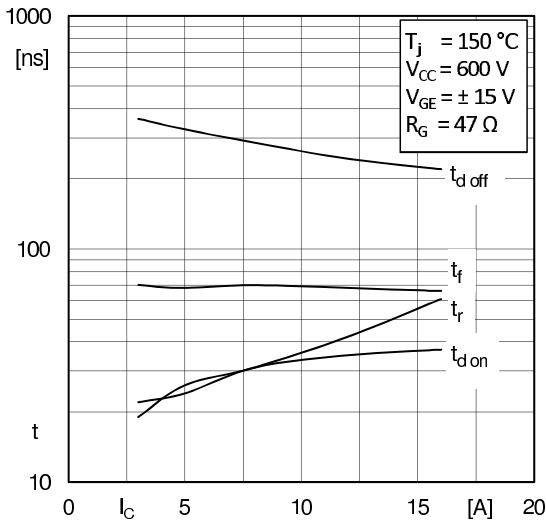

Fig. 7: Typ. switching times vs. I_C

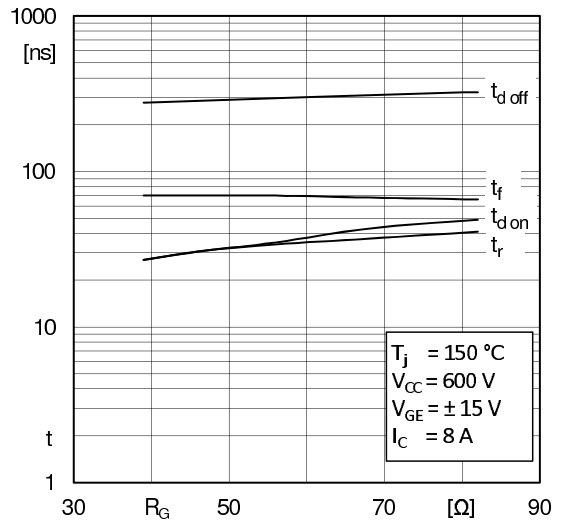

Fig. 8: Typ. switching times vs. gate resistor R_G

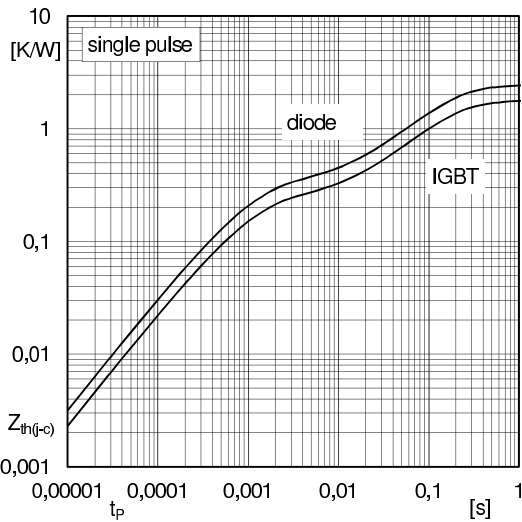

Fig. 9: Transient thermal impedance of IGBT and Diode

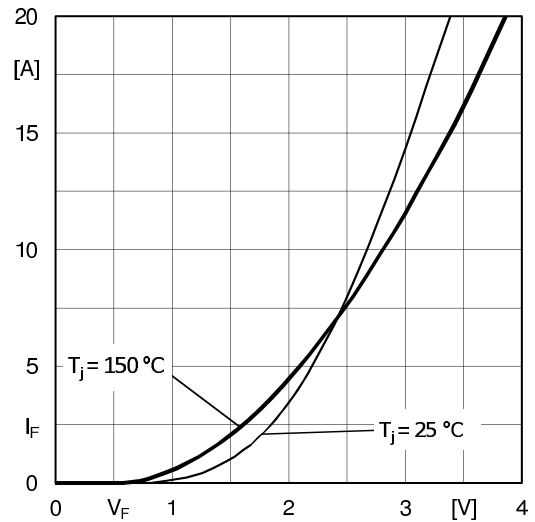

Fig. 10: CAL diode forward characteristic

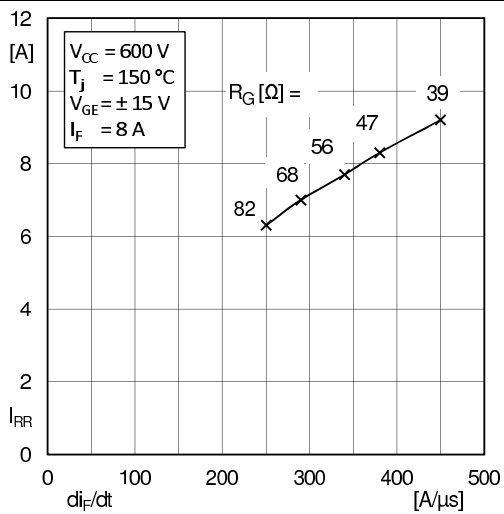

Fig. 11: Typ. CAL diode peak reverse recovery current

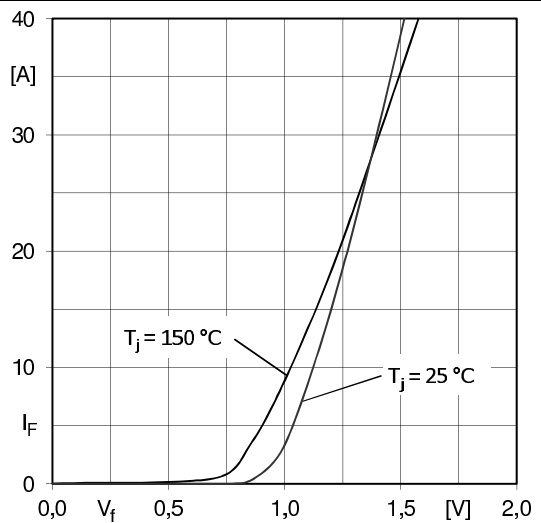
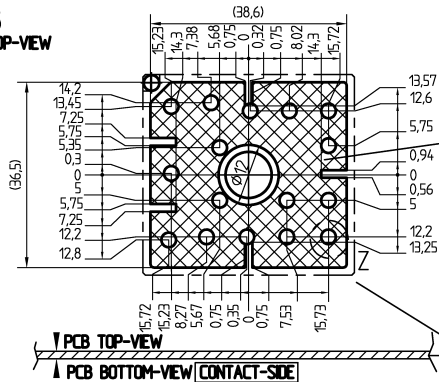

Fig. 12: Typ. input bridge forward characteristic

SKiiP 11NAB12T4V1

PCB PCB TOP-VIEW



Only for the standard pressure part:
Accessible for mounting of SMD (max height 35) on PCB by customer

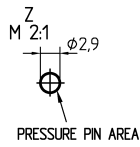

MiniSKiiP 1

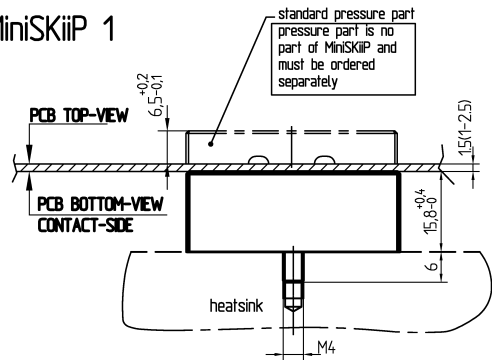

PCB BOTTOM-VIEW CONTACT-SIDE

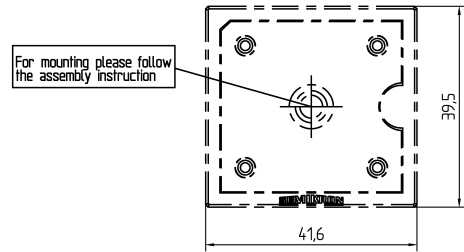
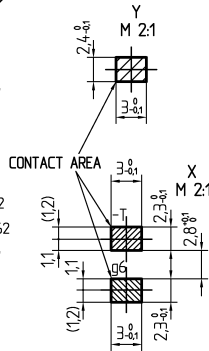
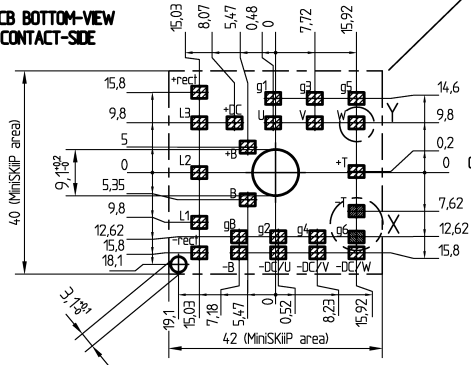

measure: mm
tolerance: ISO 2768-f

These documents are Semikron property. Semikron reserves all copyrights. All copying and transmitting of this information requires written permission. For the case of industrial property rights, Semikron reserves all rights.

pinout, dimensions

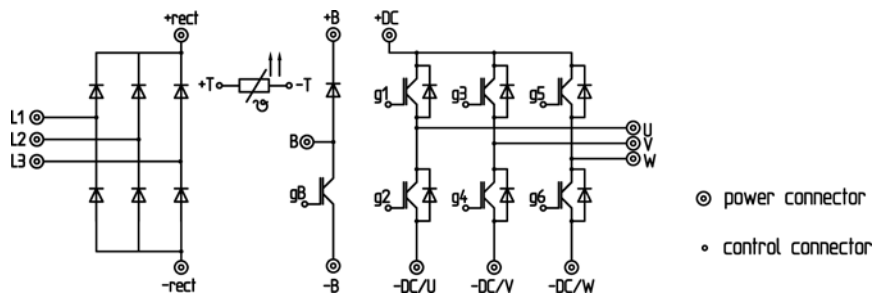

pinout

This is an electrostatic discharge sensitive device (ESDS), international standard IEC 60747-1, Chapter IX

* The specifications of our components may not be considered as an assurance of component characteristics. Components have to be tested for the respective application. Adjustments may be necessary. The use of SEMIKRON products in life support appliances and systems is subject to prior specification and written approval by SEMIKRON. We therefore strongly recommend prior consultation of our staff.