

SKiIP 02NAC12T4V1

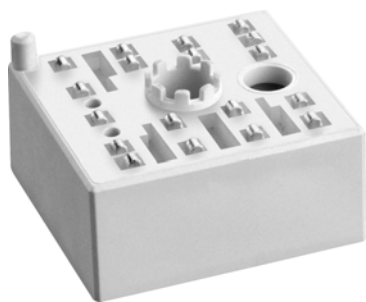

MiniSKiIP® 0

SKiIP 02NAC12T4V1

Features

- Trench 4 IGBTs
- Robust and soft freewheeling diodes in CAL technology
- Highly reliable spring contacts for electrical connections
- UL recognised: File no. E63532

Remarks

- Max. case temperature limited to $T_C=125^\circ\text{C}$
- Product reliability results valid for $T_j \leq 150^\circ\text{C}$ (recommended $T_{j,op} = -40 \dots +150^\circ\text{C}$)
- Temperature sensor: No basic insulation to main circuit, max. potential difference 850V to -DC

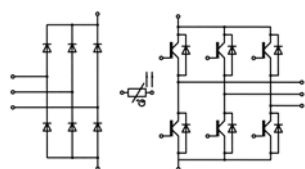

NAC

Absolute Maximum Ratings				
Symbol	Conditions		Values	Unit
Inverter - IGBT				
V_{CES}	$T_j = 25^\circ\text{C}$		1200	V
I_C	$T_j = 150^\circ\text{C}$	$T_s = 25^\circ\text{C}$	6	A
		$T_s = 70^\circ\text{C}$	6	A
I_C	$T_j = 175^\circ\text{C}$	$T_s = 25^\circ\text{C}$	6	A
		$T_s = 70^\circ\text{C}$	6	A
I_{Cnom}			4	A
I_{CRM}	$I_{CRM} = 3 \times I_{Cnom}$		12	A
V_{GES}			-20 ... 20	V
t_{psc}	$V_{CC} = 800\text{ V}$ $V_{GE} \leq 15\text{ V}$ $V_{CES} \leq 1200\text{ V}$	$T_j = 150^\circ\text{C}$	10	μs
T_j			-40 ... 175	$^\circ\text{C}$
Inverse - Diode				
V_{RRM}	$T_j = 25^\circ\text{C}$		1200	V
I_F	$T_j = 150^\circ\text{C}$	$T_s = 25^\circ\text{C}$	7.5	A
		$T_s = 70^\circ\text{C}$	7.5	A
I_F	$T_j = 175^\circ\text{C}$	$T_s = 25^\circ\text{C}$	7.5	A
		$T_s = 70^\circ\text{C}$	7.5	A
I_{Fnom}			4	A
I_{FRM}	$I_{FRM} = 3 \times I_{Fnom}$		12	A
I_{FSM}	$t_p = 10\text{ ms}$, $\sin 180^\circ$, $T_j = 150^\circ\text{C}$		36	A
T_j			-40 ... 175	$^\circ\text{C}$
Rectifier - Diode				
V_{RRM}	$T_j = 25^\circ\text{C}$		1600	V
I_F	$T_s = 25^\circ\text{C}$, $T_j = 150^\circ\text{C}$		39	A
I_{Fnom}			8	A
I_{FSM}	$t_p = 10\text{ ms}$ $\sin 180^\circ$	$T_j = 25^\circ\text{C}$	220	A
		$T_j = 150^\circ\text{C}$	200	A
I^2t	$t_p = 10\text{ ms}$ $\sin 180^\circ$	$T_j = 25^\circ\text{C}$	242	A^2s
		$T_j = 150^\circ\text{C}$	200	A^2s
T_j			-40 ... 150	$^\circ\text{C}$
Module				
$I_{t(RMS)}$	$T_{terminal} = 80^\circ\text{C}$, 20 A per spring			A
T_{stg}			-40 ... 125	$^\circ\text{C}$
V_{isol}	AC sinus 50 Hz, 1 min		2500	V

Characteristics						
Symbol	Conditions		min.	typ.	max.	Unit
Inverter - IGBT						
$V_{CE(sat)}$	$I_C = 4\text{ A}$ $V_{GE} = 15\text{ V}$ chipelevel	$T_j = 25^\circ\text{C}$	1.85	2.10		V
		$T_j = 150^\circ\text{C}$	2.25	2.45		V
V_{CE0}	chipelevel	$T_j = 25^\circ\text{C}$	0.8	0.9		V
		$T_j = 150^\circ\text{C}$	0.7	0.8		V
r_{CE}	$V_{GE} = 15\text{ V}$ chipelevel	$T_j = 25^\circ\text{C}$	263	300		$\text{m}\Omega$
		$T_j = 150^\circ\text{C}$	388	413		$\text{m}\Omega$
$V_{GE(th)}$	$V_{GE} = V_{CE}\text{ V}$, $I_C = 1\text{ mA}$		5	5.8	6.5	V
I_{CES}	$V_{GE} = 0\text{ V}$ $V_{CE} = 1200\text{ V}$	$T_j = 25^\circ\text{C}$	0.1	0.3		mA
						mA
C_{ies}	$V_{CE} = 25\text{ V}$	$f = 1\text{ MHz}$	0.25			nF
C_{oes}	$V_{GE} = 0\text{ V}$	$f = 1\text{ MHz}$	0.03			nF
C_{res}		$f = 1\text{ MHz}$	0.02			nF

SKiIP 02NAC12T4V1

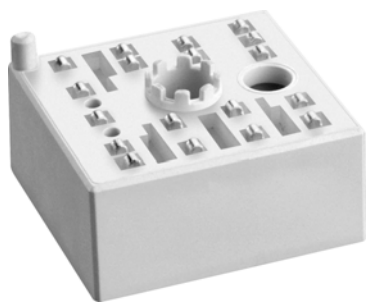

MiniSKiIP® 0

SKiIP 02NAC12T4V1

Features

- Trench 4 IGBTs
- Robust and soft freewheeling diodes in CAL technology
- Highly reliable spring contacts for electrical connections
- UL recognised: File no. E63532

Remarks

- Max. case temperature limited to $T_C=125^\circ\text{C}$
- Product reliability results valid for $T_j \leq 150^\circ\text{C}$ (recommended $T_{j,op} = -40 \dots +150^\circ\text{C}$)
- Temperature sensor: No basic insulation to main circuit, max. potential difference 850V to -DC

Characteristics					
Symbol	Conditions	min.	typ.	max.	Unit
Inverter - IGBT					
Q_G	- 8 V...+ 15 V		23		nC
R_{Gint}	$T_j = 25^\circ\text{C}$		0		Ω
$t_{d(on)}$	$V_{CC} = 600\text{ V}$	$T_j = 150^\circ\text{C}$	65		ns
t_r	$I_C = 4\text{ A}$	$T_j = 150^\circ\text{C}$	45		ns
E_{on}	$R_{G on} = 150\ \Omega$	$T_j = 150^\circ\text{C}$	0.66		mJ
$t_{d(off)}$	$R_{G off} = 150\ \Omega$	$T_j = 150^\circ\text{C}$	300		ns
t_f		$T_j = 150^\circ\text{C}$	110		ns
E_{off}	$V_{GE} = +15/-15\text{ V}$	$T_j = 150^\circ\text{C}$	0.37		mJ
$R_{th(j-s)}$	per IGBT, $\lambda_{paste}=0.8\text{ W/K}^*\text{m}$		2.49		K/W
Inverse - Diode					
$V_F = V_{EC}$	$I_F = 4\text{ A}$	$T_j = 25^\circ\text{C}$	1.8	2.1	V
	$V_{GE} = 0\text{ V}$	$T_j = 150^\circ\text{C}$	1.6	1.9	V
	chipelevel				
V_{F0}		$T_j = 25^\circ\text{C}$	1.3	1.5	V
	chipelevel	$T_j = 150^\circ\text{C}$	0.9	1.1	V
r_F		$T_j = 25^\circ\text{C}$	129	144	m Ω
	chipelevel	$T_j = 150^\circ\text{C}$	181	198	m Ω
I_{RRM}	$I_F = 4\text{ A}$	$T_j = 150^\circ\text{C}$	3.4		A
Q_{rr}	$V_{GE} = -15\text{ V}$	$T_j = 150^\circ\text{C}$	0.95		μC
	$V_{CC} = 600\text{ V}$				
E_{rr}	$di/dt_{off} = 110\text{ A}/\mu\text{s}$	$T_j = 150^\circ\text{C}$	0.34		mJ
$R_{th(j-s)}$	per Diode, $\lambda_{paste}=0.8\text{ W/K}^*\text{m}$		2.53		K/W
Rectifier - Diode					
$V_F = V_{EC}$	$I_F = 8\text{ A}$	$T_j = 25^\circ\text{C}$	1	1.2	V
	chipelevel	$T_j = 125^\circ\text{C}$	0.9	1.1	V
V_{F0}		$T_j = 25^\circ\text{C}$	0.9	1	V
	chipelevel	$T_j = 125^\circ\text{C}$	0.7	0.8	V
r_F		$T_j = 25^\circ\text{C}$	15	29	m Ω
	chipelevel	$T_j = 125^\circ\text{C}$	21	34	m Ω
$R_{th(j-s)}$	per Diode, $\lambda_{paste}=0.8\text{ W/K}^*\text{m}$		1.5		K/W
Module					
M_s	to heat sink		2	2.5	Nm
W			20		g
Temperature Sensor					
R_{100}	$T_r = 100^\circ\text{C}$, tolerance = 3 %		1670 \pm 3%		Ω
$R(T)$	$R(T)=1000\Omega[1+A(T-25^\circ\text{C})+B(T-25^\circ\text{C})^2]$ $A = 7.635 \cdot 10^{-3}\text{ }^\circ\text{C}^{-1}$, $B = 1.731 \cdot 10^{-5}\text{ }^\circ\text{C}^{-2}$				

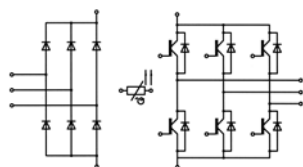

NAC

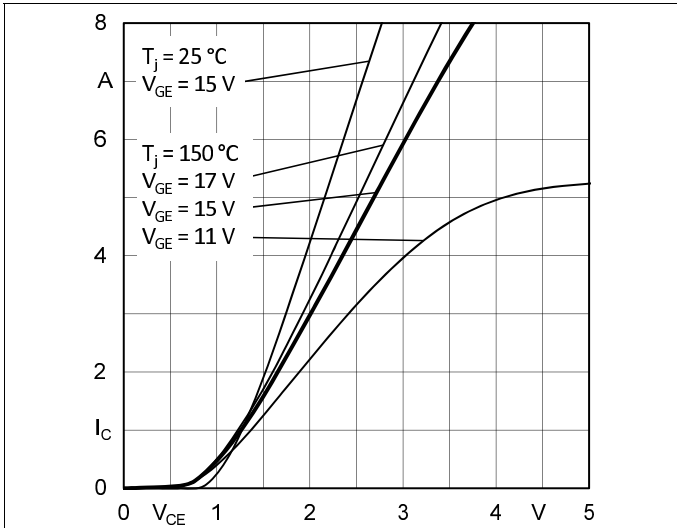

Fig. 1: Typ. output characteristic

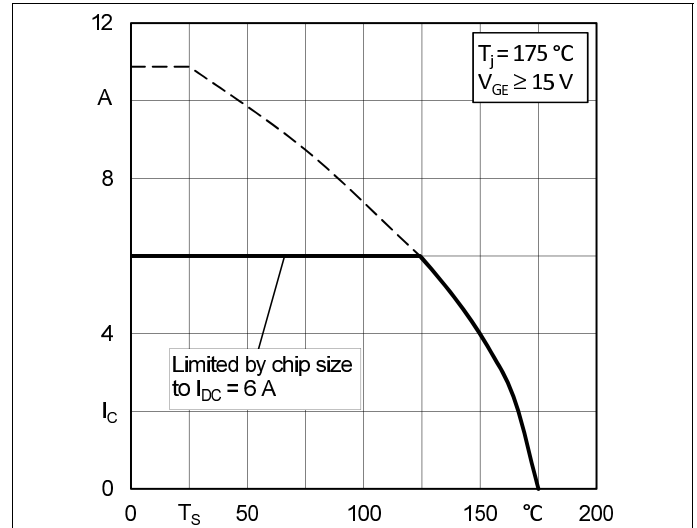

Fig. 2: Typ. rated current vs. temperature $I_C = f(T_s)$

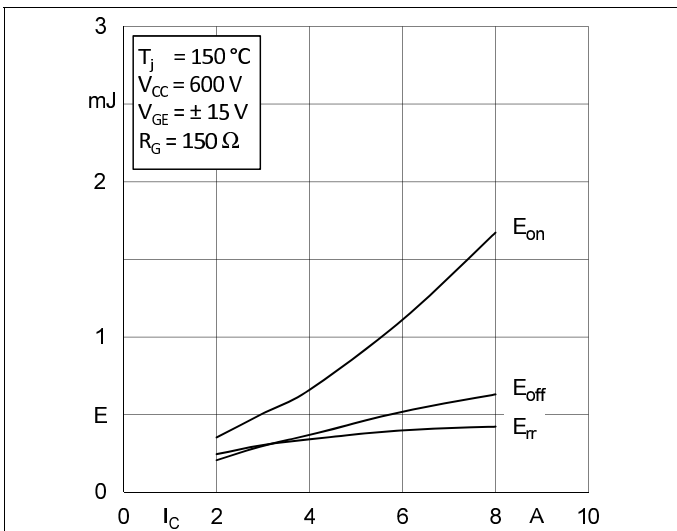

Fig. 3: Typ. turn-on /-off energy = $f(I_C)$

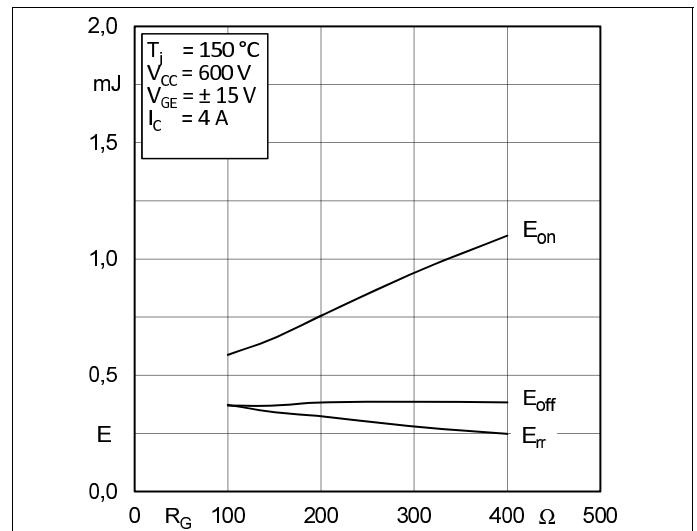

Fig. 4: Typ. turn-on /-off energy = $f(R_G)$

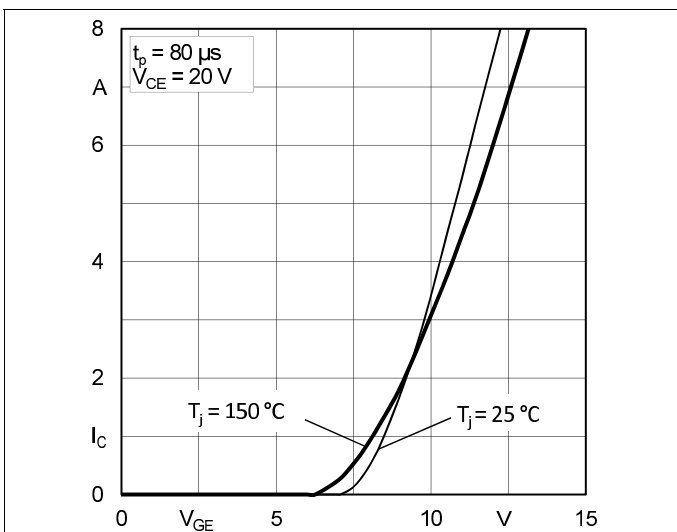

Fig. 5: Typ. transfer characteristic

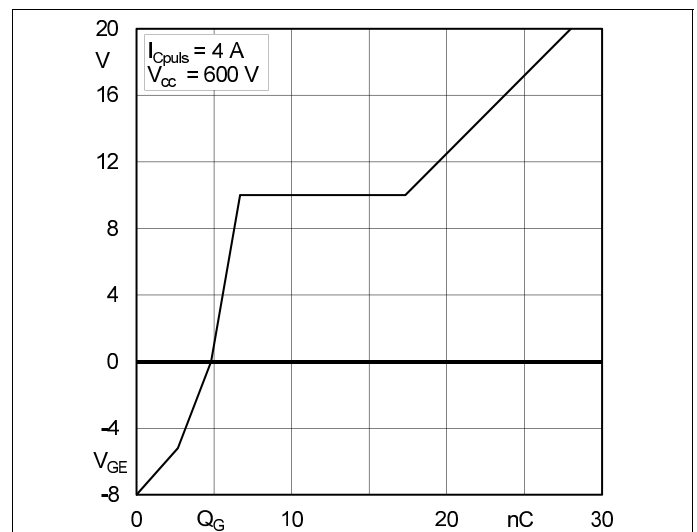

Fig. 6: Typ. gate charge characteristic

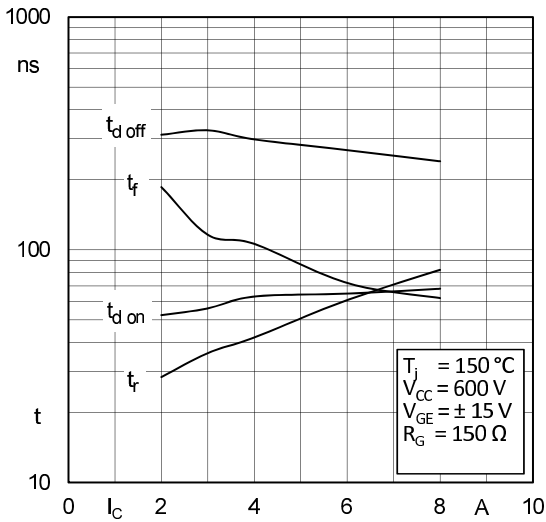

Fig. 7: Typ. switching times vs. I_c

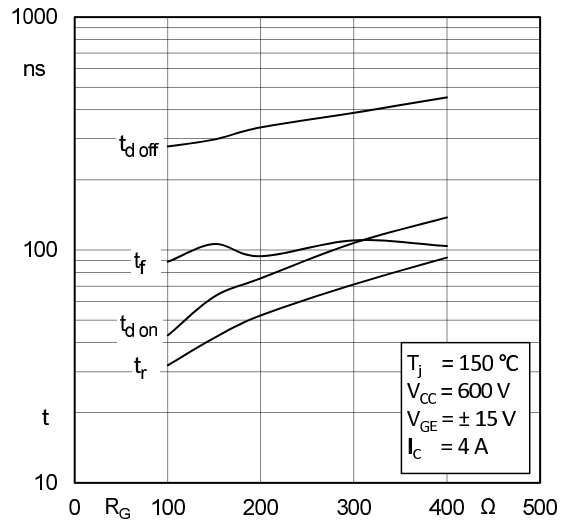

Fig. 8: Typ. switching times vs. gate resistor R_G

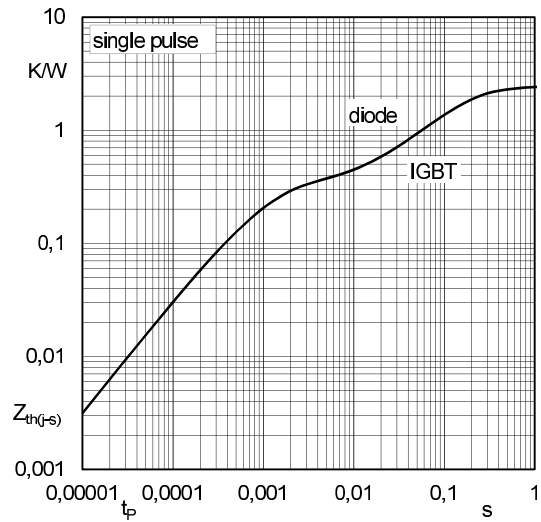

Fig. 9: Transient thermal impedance of IGBT and Diode

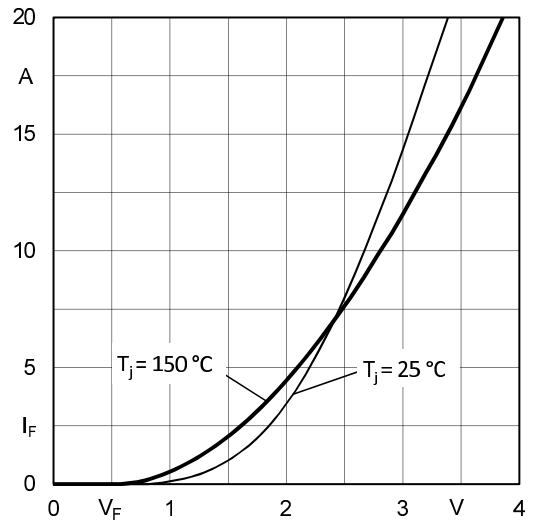

Fig. 10: CAL diode forward characteristic

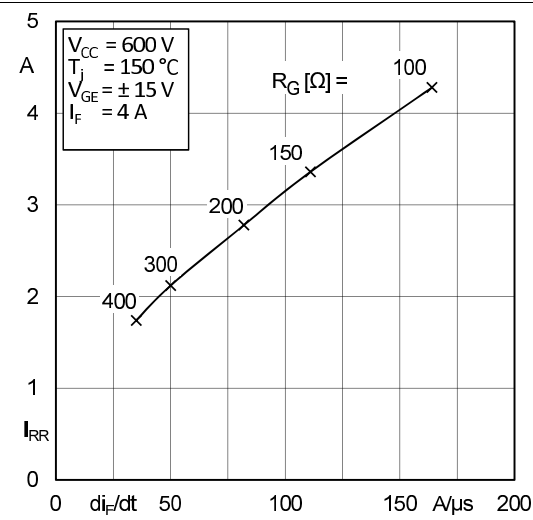

Fig. 11: Typ. CAL diode peak reverse recovery current

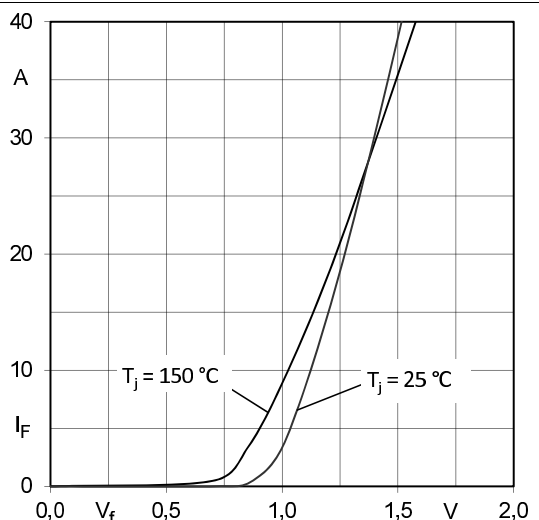
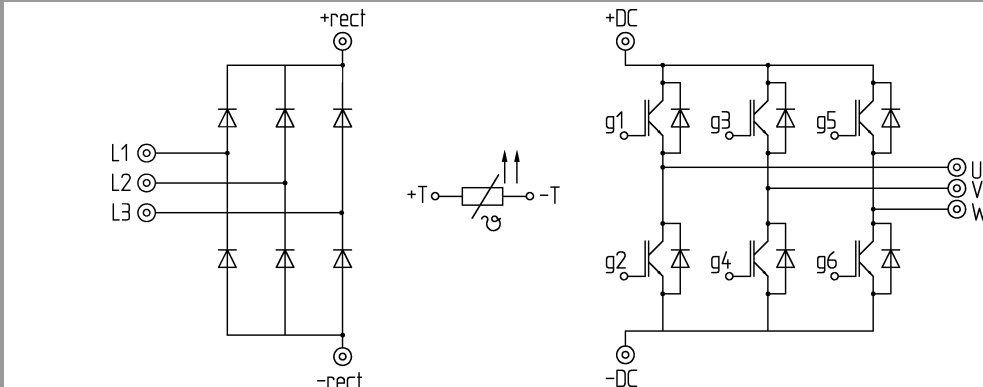
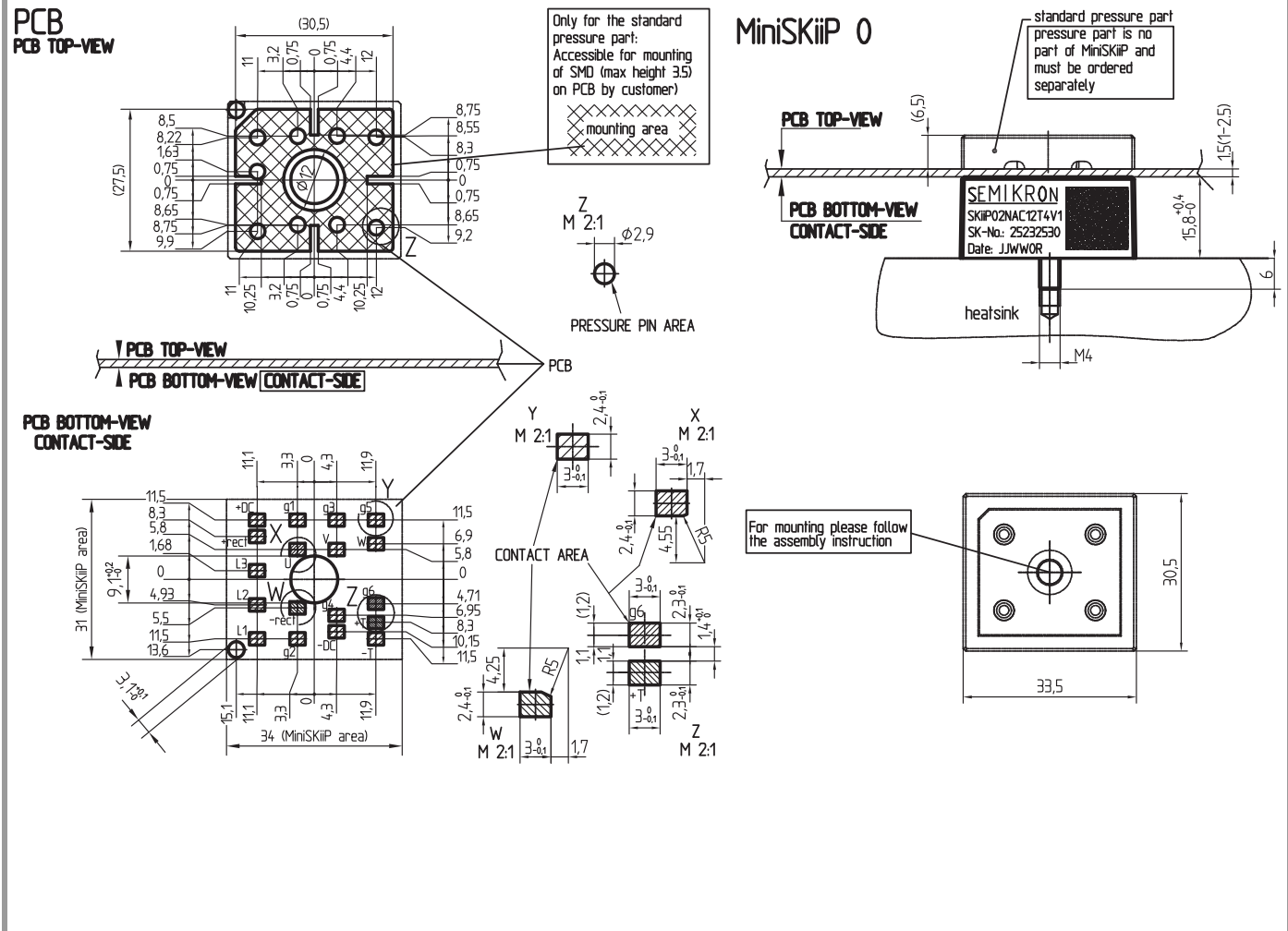

Fig. 12: Typ. input bridge forward characteristic



This is an electrostatic discharge sensitive device (ESDS), international standard IEC 60747-1, Chapter IX

* The specifications of our components may not be considered as an assurance of component characteristics. Components have to be tested for the respective application. Adjustments may be necessary. The use of SEMIKRON products in life support appliances and systems is subject to prior specification and written approval by SEMIKRON. We therefore strongly recommend prior consultation of our staff.